

MPX-7202

User's Manual

Edition 1.01

2010/04/29



Copyright

Copyright 2010 all rights reserved. This document is copyrighted and all rights are reserved. The information in this document is subject to change without prior notice to make improvements to the products.

This document contains proprietary information and protected by copyright. No part of this document may be reproduced, copied, or translated in any form or any means without prior written permission of the manufacturer.

All trademarks and/or registered trademarks contains in this document are property of their respective owners.

Disclaimer

The company shall not be liable for any incidental or consequential damages resulting from the performance or use of this product.

The company does not issue a warranty of any kind, express or implied, including without limitation implied warranties of merchantability or fitness for a particular purpose.

The company has the right to revise the manual or include changes in the specifications of the product described within it at any time without notice and without obligation to notify any person of such revision or changes.

Trademark

All trademarks are the property of their respective holders.

Any questions please visit our website at <http://www.commell.com.tw>.

Packing List:

Hardware:

MPX-7202 USB3.0 Super-Speed PCI Express mini card x1

IO Module:



2 x USB 3.0
(ADP-USB)

Cable kit:



DF14 20PIN For 1394B
(OALH20-L20)



4PIN HSG to 6PIN for power
(OAL4P-6)

CD Content:

Driver & User's Manual

1.0 <Product Specification>

General Specification	
Form Factor	PCI Express mini card
Controller	NEC Chip
Features	2 x USB 3.0 provides up to 4.8Gbps of transferring rate Support USB 2.0 (480M/s) /USB 1.1 (12Mb/s) devices
Power Requirement	+3.3V & +12V
Accessories	1 x USB3.0 Type A IO Module 1 x DF14 20-pin Cable (For USB3.0) 1 x DC input Cable (For power)
OS	Win XP, Win 7,Vista
Dimensions (W x D)	30.00mm x 50.95mm

1.1 <Component Placement>

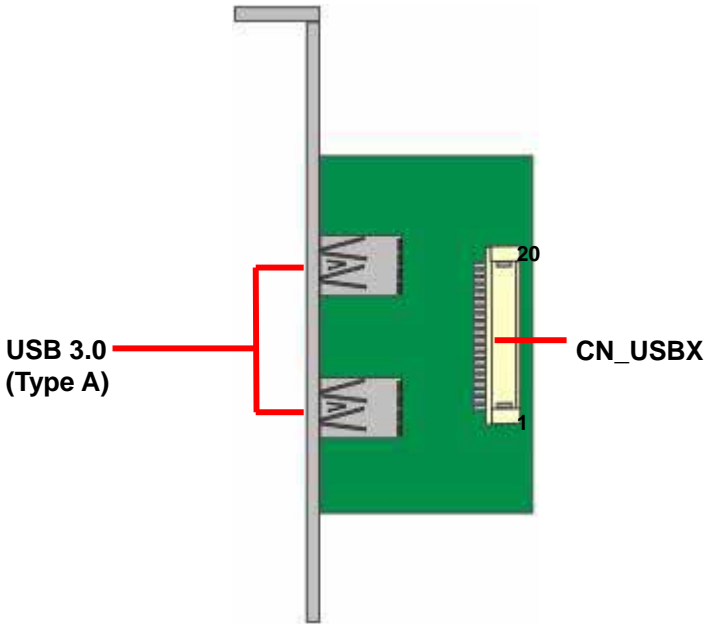
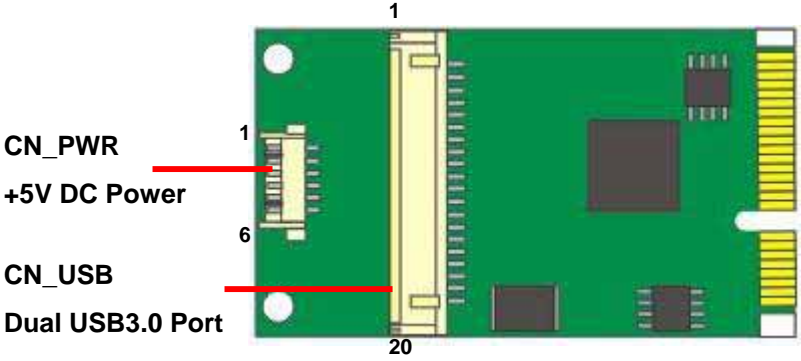

1.2 <Mechanical Drawing>

MPX-7202

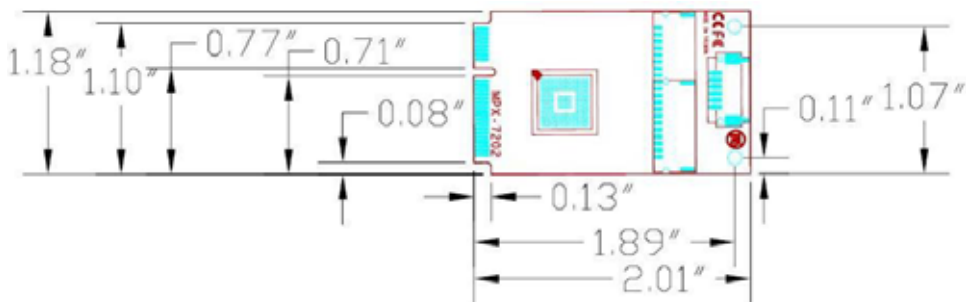

Unit: inch

IO Module (ADP-USB)

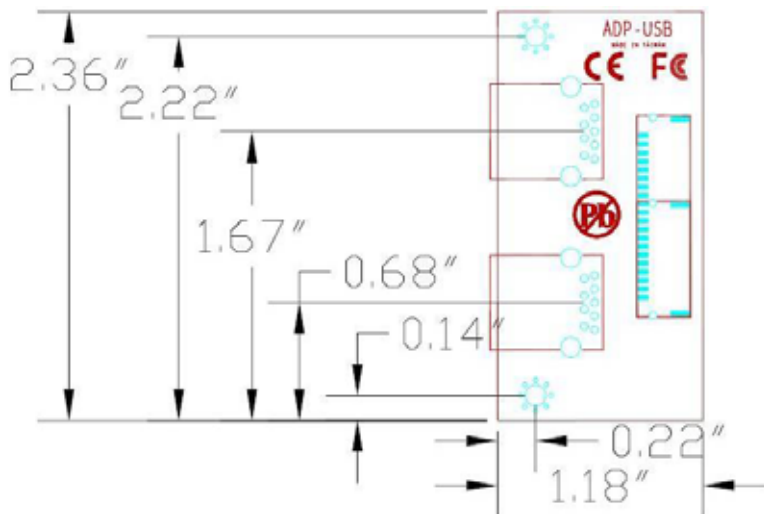

Unit: inch

1.3 <Connector Reference>

<MPX-7202>

Connector: CN_USB

Type: DF14 20-pin pitch=1.25mm

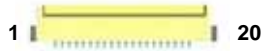

Pin	Description	Pin	Description
1	U3T1+	2	U3T1-
3	U2T1-	4	U2T1+
5	N/C	6	U3R1+
7	U3R1-	8	+5V
9	GND	10	GND
11	U3T2+	12	U3T2-
13	U2T2-	14	U2T2+
15	N/C	16	U3R2+
17	U3R2-	18	+5V
19	GND	20	GND

Connector: CN_PWR

Type: 1252 6-pin pitch=1.25mm

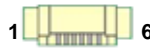

Pin	Description	Pin	Description
1	N/C	2	N/C
3	GND	4	GND
5	+5V	6	+5V

<ADP-USB>

Connector: CN_USBX

Type: DF14 20-pin pitch=1.25mm



Pin	Description	Pin	Description
1	XU3T1+	2	XU3T1-
3	XU2T1-	4	XU2T1+
5	N/C	6	XU3R1+
7	XU3R1-	8	+5V
9	GND	10	XGND
11	XU3T2+	12	XU3T2-
13	XU2T2-	14	XU2T2+
15	N/C	16	XU3R2+
17	XU3R2-	18	+5V
19	GND	20	GND

Contact Information

Any advice or comment about our products and service, or anything we can help you please don't hesitate to contact with us. We will do our best to support you for your products, projects and business.

Taiwan Commate Computer Inc.

Address	19F, No. 94, Sec. 1, Shin Tai Wu Rd., Shi Chih Taipei Hsien, Taiwan
TEL	+886-2-26963909
FAX	+886-2-26963911
Website	http://www.commell.com.tw
E-Mail	info@commell.com.tw (General Information) tech@commell.com.tw (Technical Support)

Commell is the trademark of Taiwan Commate Computer INC.