

LE-380

3.5 inch Miniboard

User's Manual

2012/01/05

Version:1.0

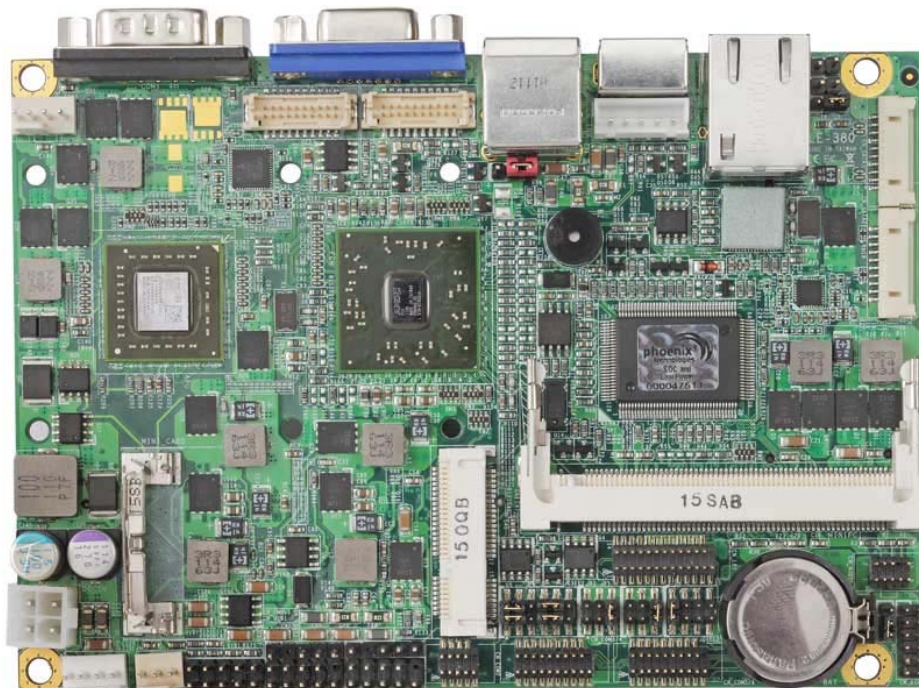

Copyright

Copyright 2012. All rights reserved. This document is copyrighted and all rights are reserved. The information in this document is subject to change without prior notice to make improvements to the products.

This document contains proprietary information and protected by copyright. No part of this document may be reproduced, copied, or translated in any form or any means without prior written permission of the manufacturer.

All trademarks and/or registered trademarks contains in this document are property of their respective owners.

Disclaimer

The company shall not be liable for any incidental or consequential damages resulting from the performance or use of this product.

The company does not issue a warranty of any kind, express or implied, including without limitation implied warranties of merchantability or fitness for a particular purpose.

The company has the right to revise the manual or include changes in the specifications of the product described within it at any time without notice and without obligation to notify any person of such revision or changes.

Trademark

All trademarks are the property of their respective holders.

Any questions please visit our website at <http://www.commell.com.tw>

Packing List:

Please check the package content before you starting using the board.

Hardware:

LE-380 3.5" Miniboard x 1

Cable Kit:



DC Power Cable x 1
(OALDC-A)



1 to 3 power output
cable
(OAL4P-2)

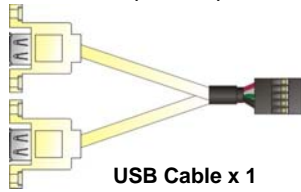

USB Cable x 1
(OALUSBA-3)



PS/2 keyboard & mouse cable x 1
(OALPS2/MK)



DF14 10Pin for SATA x 2
(OALSATA7-H10)



Audio Cable x 1
(OALPJ-HDUNB)



COM port Cable x 1
(OALPS-BKU1NB)



SATA Power Cable x 1
(OAL4P-S2)



DVI Module With DVI Cable x 1
(BADPDVI-A + OALDVI-DF13)

Optional Cable Kit:



Dual COM PORT cable
(OALPS-BKU2NB)



Printer Cable x 1
(OAL1P-UNB-30)

Printed Matters:

Driver CD x 1 (Including User's Manual)

Index

Chapter 1 <Introduction>	6
1.1 <Product Overview>.....	6
1.2 <Product Specification>	7
1.3 <Mechanical Drawing>	9
1.4 <Block Diagram>	10
Chapter 2 <Hardware Setup>	11
2.1 <Connector Location>	11
2.2 <Jumper Reference>.....	13
2.3 <Connector Reference>	14
2.3.1 <Internal Connector>	14
2.3.2 <External Connector>	14
2.4 <CPU and Memory Setup>.....	15
2.5 <CMOS & ATX Setup>	16
2.6 <SATA & CFast Interface>.....	17
2.8 <LAN Interface>	18
2.9 <Onboard Display Interface>	19
2.9.1 <Analog VGA Interface>.....	19
2.9.2 <Digital Display>.....	20
2.9.3 <DVI Interface >	24
2.10 <Onboard Audio Interface>.....	25
2.11 <USB2.0 Interface>	26
2.12 <GPIO Interface>	27
2.13 <Serial Port Jumper Setting >.....	28
2.14 <Power & FAN Connector >.....	29
2.14.1 <Power Input>.....	29
2.14.2 <Power Output>.....	30
2.14.3 <Fan Connector>.....	30
2.15 <Indicator and Switch>.....	31
Chapter 3 <BIOS Setup>	33

Appendix A <I/O Port Pin Assignment>	35
A.1 <SATA Port>	35
A.2 <IrDA Port>.....	35
A.3 <SMBUS Port>	35
A.4<LPT Port>.....	36
A.5 < CRT Port >	36
A.6 <Serial Port>.....	37
A.7 <LAN Port>.....	37
A.8 <LAN LED Port>.....	37
Appendix B <Flash BIOS>	39
B.1 BIOS Auto Flash Tool.....	39
B.2 Flash Method	39
Appendix C <System Resources>	40
C.1 <I/O Port Address Map>.....	40
C.2 <Memory Address Map >.....	42
C.3 < System IRQ Resources >.....	43
Appendix D <Programming GPIO's>	44
Appendix E <Watch Dog timer Setting >	45
Appendix F <AMD Hing Definition Audio Device >	46
Contact Information	48

(This page is left for blank)

Chapter 1 <Introduction>

1.1 <Product Overview>

LE-380 is the 3.5 inches embedded motherboard with AMD G-T56N platform, with onboard VGA, Realtek ALC888 HD Codec audio, Giga LAN interface. Based on the AMD G-T56N Processor , the board provides many advanced features for reduced power consumption.

A55E Chipset

The board integrates AMD A55E, to provide built-in UniChrome Pro 3D / 2D Graphics with MPEGII decoder, and supports DDR3 1066/1333 memory up to 4G of capacity.

18-bit LVDS LCD interface

The board provides onboard 18-bit LVDS LCD interface, supports up to 1400 x 1050 of UXGA high resolution.

Flexible Extension Interface

The board also provides CFast Card socket, one mini PCI socket and one Mini card socket.

1.2 <Product Specification>

General Specification

Form Factor	3.5 inch miniboard
CPU	AMD G-Series T56N Processor 1.65GHz
Memory	1 x 204-pin DDR3 1066/1333 SO-DIMM SDRAM up to 4G
Chipset	AMD A55E FCH
Watchdog Timer	System reset programmable watchdog timer with 1 ~ 255 sec./min. of timeout value
Real Time Clock	Chipset integrated RTC with onboard lithium battery
Serial ATA	2 x serial ATAll interface with 300MB/s transfer rate CFast Card socket (shared with CN_SATA2)

Multi-I/O Port

Chipset	Winbond W83627DHG-P
Serial Port	One RS-232/422/485 serial port and Five RS-232
USB Port	Six Hi-Speed USB 2.0 ports with 480Mbps of transfer rate
IrDA Port	One IrDA compliant Infrared interface supports SIR
K/B & Mouse	PS/2 keyboard and mouse port
GPIO	One 12-pin Digital I/O connector with 8-bit programmable I/O interface

VGA Display Interface

Chipset	AMD G-Series T56N Processor
Frame Buffer	Up to 512MB shared with system memory
Display Type	CRT, LCD monitor with analog display, single channel DVI, LVDS
Connector	External DB15 female connector Onboard 20-Pin LVDS and 5-Pin inverter connector Onboard 20-Pin DVI

Ethernet Interface

Controller	1 x Intel® 82583V Gigabit Ethernet controller
Type	Triple speed 10/100/1000Base-T auto-switching Fast Ethernet Full duplex, IEEE802.3U compliant
Connector	One External RJ45 connector with LED

Audio Interface

Chipset	REALTEK ALC888
Interface	Stereo audio Line-out and MIC-in
Connector	Onboard audio connector with pin header

Expansive Interface

PCIE Mini Card	1 x PCIE Mini Card socket
Mini PCI Card	1 x Mini PCI Card socket

Power and Environment

Power Requirement	DC 5V~24V input with onboard 4-pin connector
Dimension	146 (L) x 101(H) mm
Temperature	Operating within 0 ~ 60°C Storage within -20 ~ 85°C

The specifications may be different as the actual production.
For further product information please visit the website at <http://www.commell.com.tw>

1.3 <Mechanical Drawing>

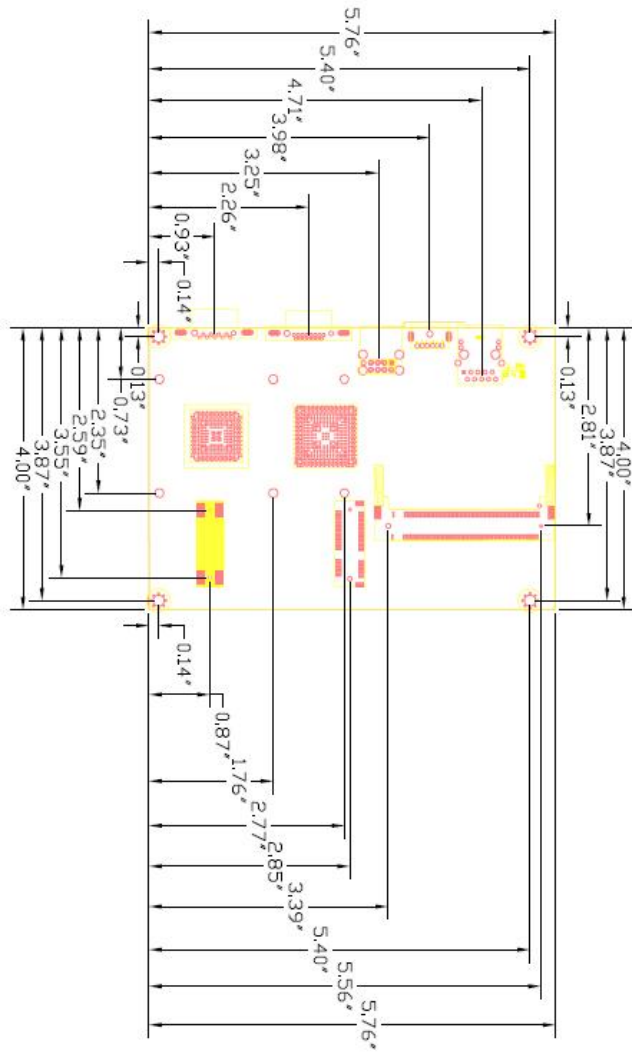

Unit: inch

1.4 <Block Diagram>

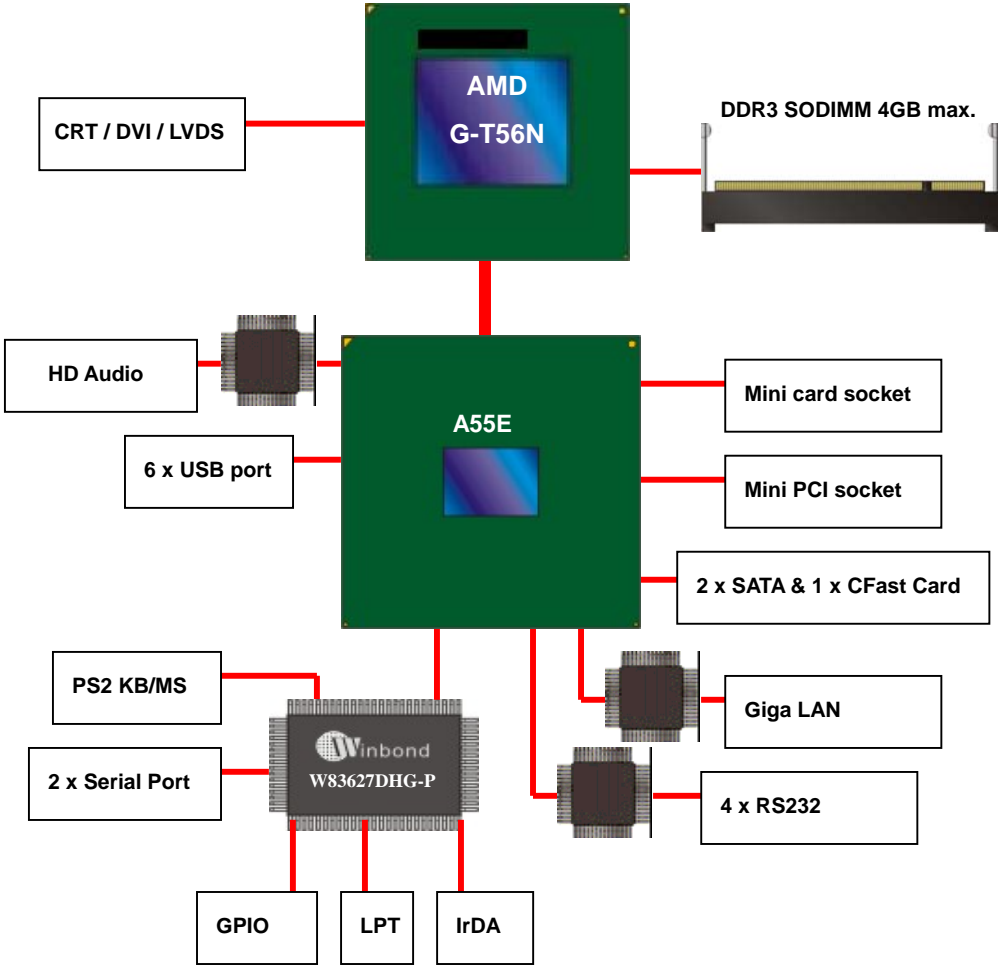

Chapter 2 <Hardware Setup>

2.1 <Connector Location>

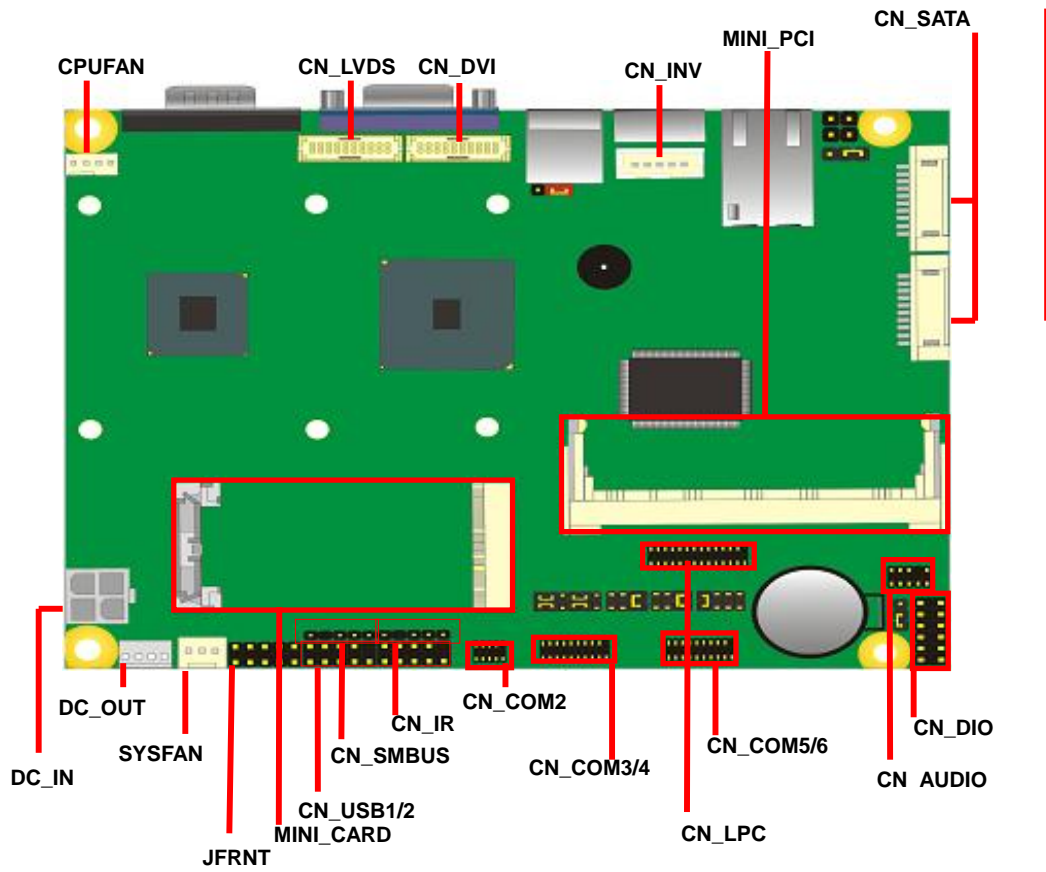

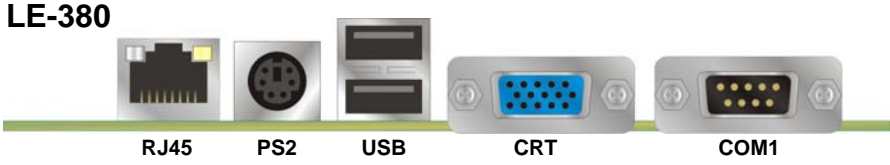
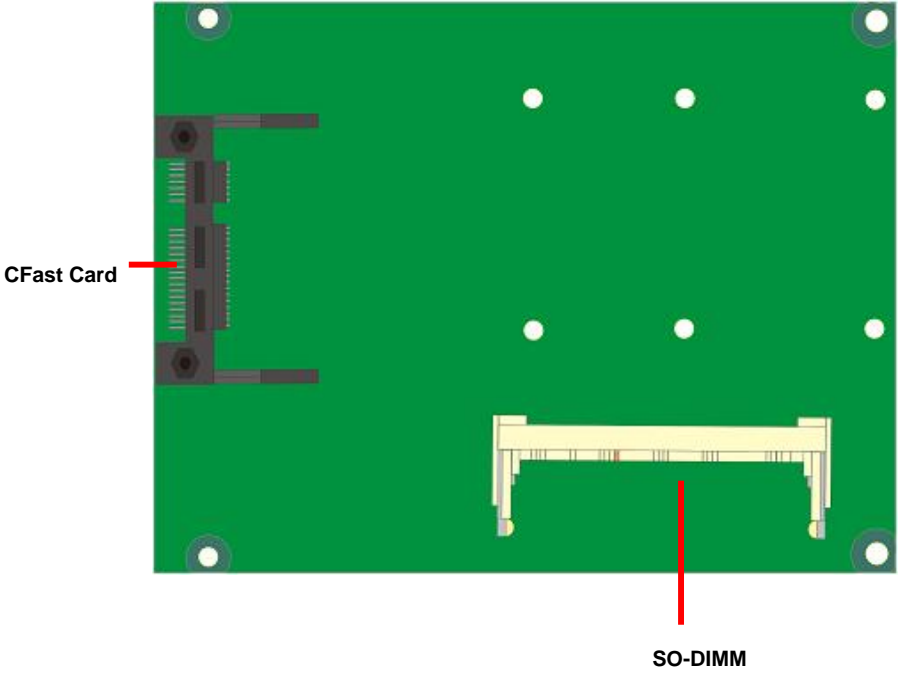

2.2 <Jumper Reference>

Jumper	Function
JRTC	CMOS Operating/Clear Setting
JAT	AT/ATX Mode Setting
JCSEL1/2	COM2 RS232/422/485/IrDA Mode Setting
JP1	Com4 Voltage Setting(For Pin 9)
JP2	Com3 Voltage Setting(For Pin 9)
JVLCD	LCD Panel Voltage Setting

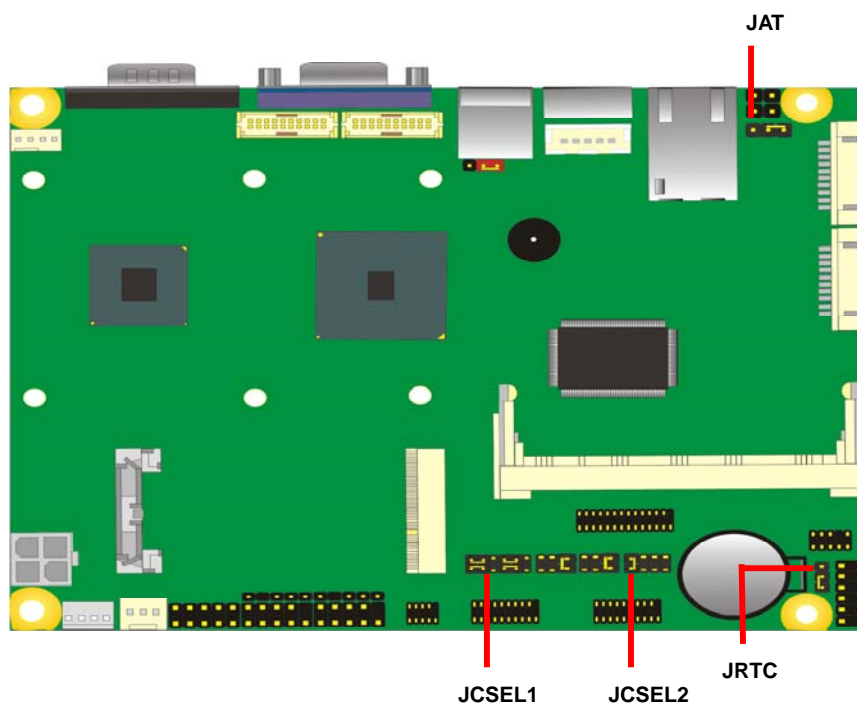

2.3 <Connector Reference>

2.3.1 <Internal Connector>

Connector	Function	Remark
SO-DIMM	204 -pin DDR3 SO-DIMM SDRAM slot	
CN_SATA	10-pin SATA Cable connector	
CFast	CFast Card socket	
MINI_CARD	PCIE mini card socket	
MINI_PCI	mini PCI socket	
CN_LVDS	20 -pin LVDS connector	
CN_DVI	20 -pin LVDS connector	
CN_INV	5-pin LCD inverter connector	
CN_USB1/2	5 x 2-pin USB connector	
CN_AUDIO	5 x 2-pin audio connector	
CN_COM2	5 x 2-pin com connector	
CN_COM3/4	10 x 2-pin com connector	
CN_COM5/6	10 x 2-pin com connector	
CN_IR	5-pin IrDA connector	
CN_DIO	6 x 2-pin digital I/O connector	
JFRNT	10-pin switch/indicator connector	
CPUFAN	4-pin CPU cooler fan connector	
SYSFAN	3-pin system cooler fan connector	
DC_OUT	4-pin power output connector	
DC_IN	DC input connector	
CN_LPT	26 -pin header for LPT Port connector	

2.3.2 <External Connector>

Connector	Function	Remark
COM1	DB9 Serial port connector	
CRT	DB15 VGA connector	
USB	Dual USB 2.0 connector	
PS2	PS/2 keyboard and mouse connector	
RJ45	RJ45 LAN connector	

2.4 <CPU and Memory Setup>

The board provides one 204-pin DDR3 SO-DIMM to support DDR3 1066/1333 memory modules up to 4GB.

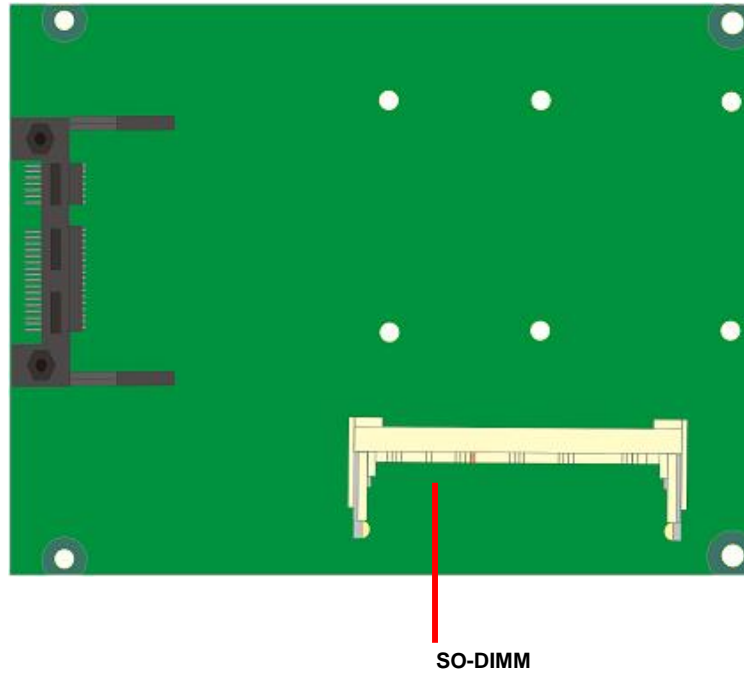

2.5 <CMOS & ATX Setup>

The board's data of CMOS can be setting in BIOS. If the board refuses to boot due to inappropriate CMOS settings, please remove battery to clear (reset) the CMOS to its default values.

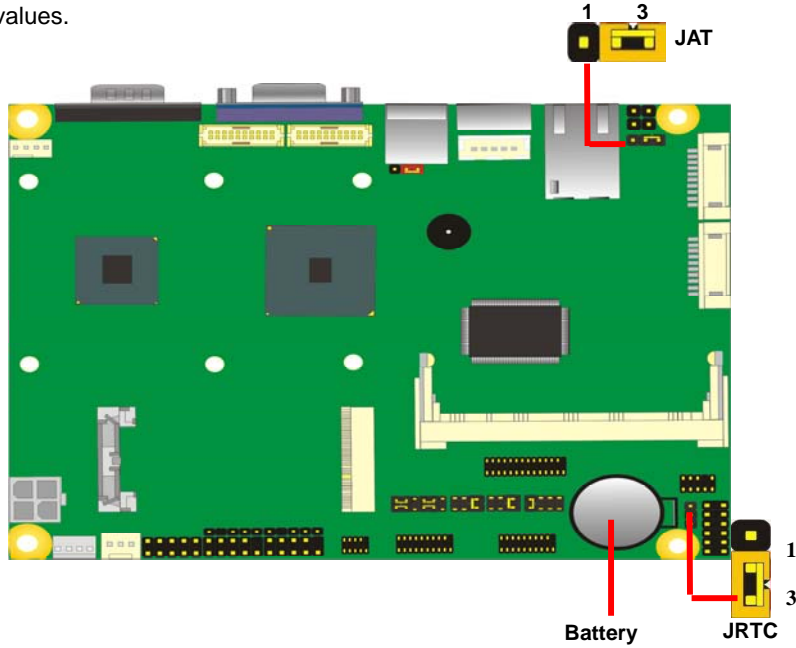

The board has a jumper to switch AT power mode (automatic power on) or standard ATX mode.

Jumper: **JAT**

Type: onboard 3-pin jumper

JAT	Mode
1-2	AT Mode
2-3	ATX Mode

Default setting

Jumper: **JRTC**

Type: onboard 3-pin jumper

JRTC	Mode
1-2	Clear CMOS
2-3	Normal Operation

Default setting

2.6 <SATA & CFast Interface>

Based on AMD A55E, the board provides one Serial ATAII interfaces with up to 300MB/s of transfer rate.

The board has one CFast card socket on the solder side.

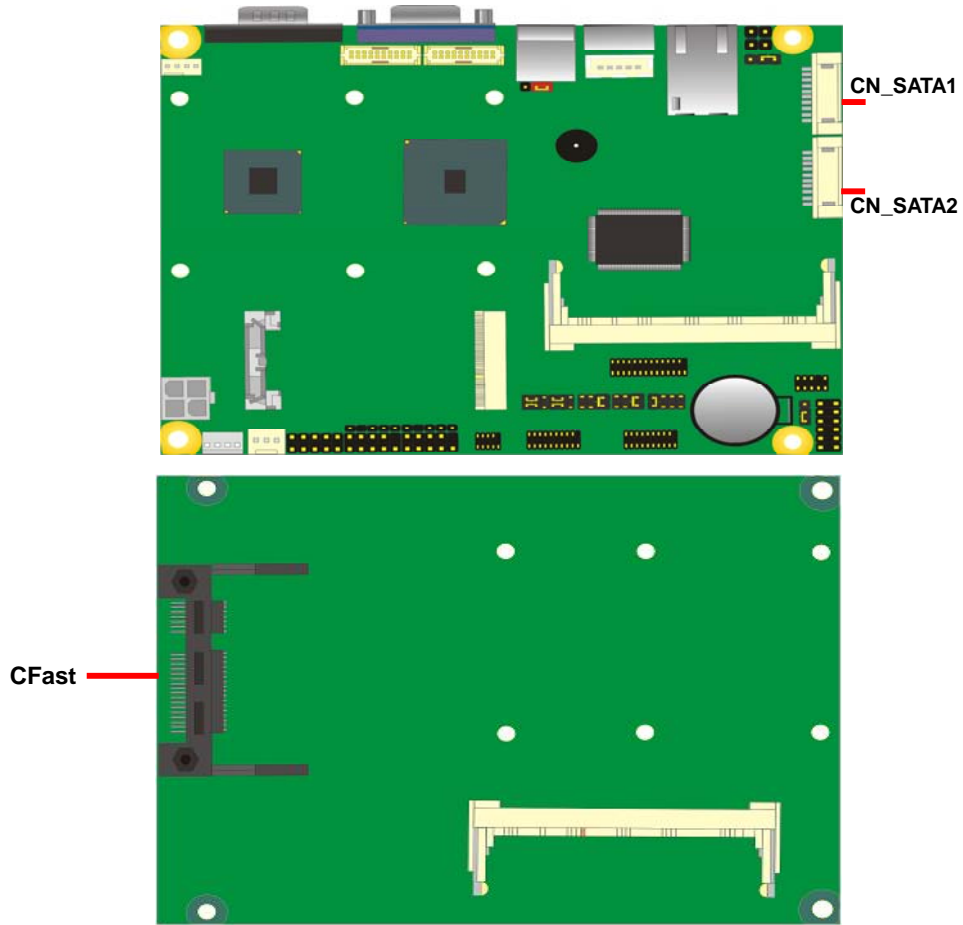

Note: CFast Card shared with CN_SATA2.

2.8 <LAN Interface>

The Intel® 82583V supports triple speed of 10/100/1000Base-T, with IEEE802.3 compliance and Wake-On-LAN supported.



2.9 <Onboard Display Interface>

Based on AMD G-T56N chipset with built-in AMD Radeon HD 6300 series Graphics, the board provides one DB15 connector on rear external I/O port, and two 20-pin DVI and LVDS interface with 5-pin LCD backlight inverter connector. The board provides dual display function with clone mode and extended desktop mode for CRT, DVI and LVDS.

2.9.1 <Analog VGA Interface>

Please connect your CRT or LCD monitor with DB15 male connector to the onboard DB15 female connector on rear I/O port.

The board supports up to 1920 x 1080 (WUXGA) of resolution.

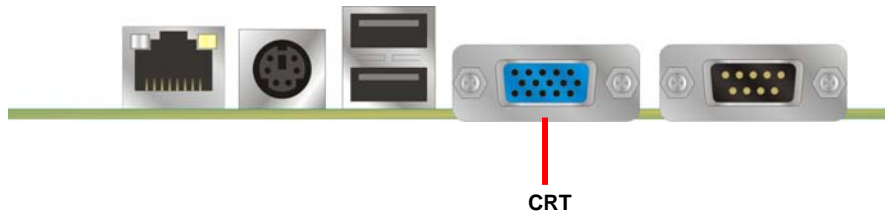

2.9.2 <Digital Display>

The board provides one 20-pin LVDS connector for 18 bit single channel panel, with one LCD backlight inverter connector and one jumper for panel voltage setting.

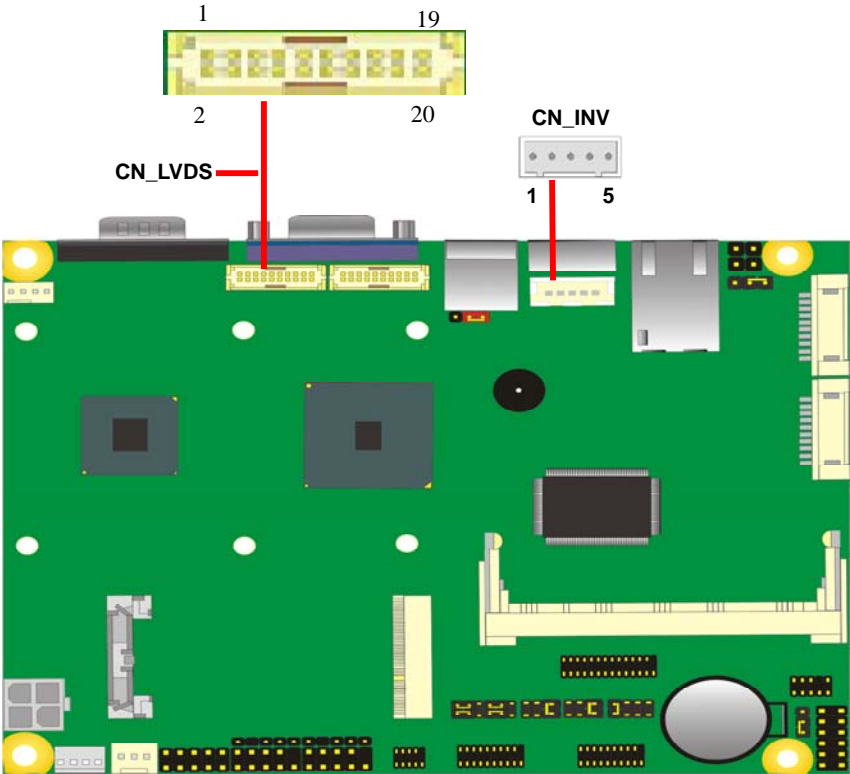

Connector: **CN_INV**

Type: 5-pin Inverter power connector

Connector model: **JST B5B-XH-A**

Pin	Description
1	+12V
2	LVDS_VARY_BL
3	GND
4	GND
5	INV_ON

Jumper: **JVLCD**

Type: 3-pin Power select jumper

Pin	Description
1-2	+5V
2-3	+3.3V

Default: 2-3Connector: **CN_LVDS**

Type: onboard 20-pin connector for LVDS connector

Connector model: **HIROSE DF13-20DP-1.25V**

Pin	Signal	Pin	Signal
2	LCDVCC	1	LCDVCC
4	GND	3	GND
6	TX0P	5	TX0N
8	TX1N	7	GND
10	GND	9	TX1P
12	TX2P	11	TX2N
14	CLKN	13	GND
16	GND	15	CLKP
18	AUXN	17	AUXP
20	GND	19	GND

To setup the LCD, you need the component below:

1. A panel with LVDS interfaces.
2. An inverter for panel's backlight power.
3. A LCD cable and an inverter cable.

For the cables, please follow the pin assignment of the connector to make a cable, because every panel has its own pin assignment, so we do not provide a standard cable; please find a local cable manufacture to make cables.

LCD Installation Guide:

1. Preparing the LE-380, LCD panel and the backlight inverter

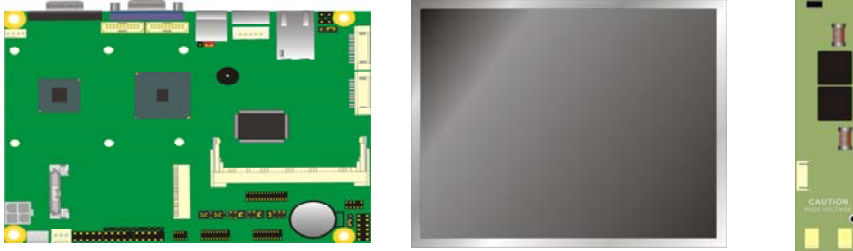

2. You would need a LVDS type cable.



3. To connect all of the devices well.

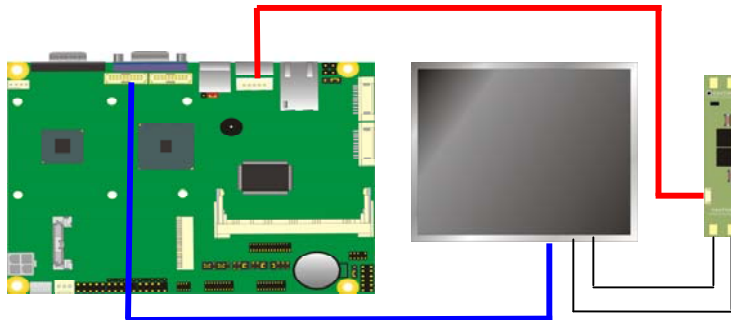

After setup the devices well, you need to select the LCD panel type in the BIOS.

Platform	Item Specific
Platform Bios Specification	NB PCIE Display connect type
External USB Host Controller	[Disabled]
LAN 1 Network Boot ROM	[Disabled]
LAN 2 Network Boot ROM	[Disabled]
AMD Fusion Utility	[Disabled]
Travis-L Support	[Disabled]
ACPI P-state	[Enabled]
LVDS DPA support	[LVDS]
LVDS OPTION	[LVDS 800x600]
LVDS DPB support	[Default Settin]
PCIE GPP	[GPP X1X1X1]
Universal Console Redirection	[Disabled]

F1 Help ↑ Select Item +/- Change Values F9 Setup Defa
Esc Exit ↔ Select Menu Enter Select ▶ Sub-Menu F10 Save and E

The panel type mapping is list below:

LE-380 BIOS panel type selection form	
On board Single channel LVDS	
18bit	
NO.	Output format
1	800 x 600
2	1024 x 768
3	1280 x 720
4	1280 x 800
5	1280 x 1024
6	1366 x 768
7	1440 x 900

2.9.3 <DVI Interface >

The board also comes with a DVI interface. Supports up to 1600 x 1200 (WUXGA) of resolution.

Type: onboard 20-pin connector for LVDS connector

Connector model: HIROSE DF13-20DP-1.25V

Pin Number	Assignment	Pin Number	Assignment
1	+5V	2	+3.3V
3	HPD	4	Ground
5	TMDSTX0N	6	TMDSTX0P
7	Ground	8	TMDSTX1N
9	TMDSTX1P	10	Ground
11	TMDSTX2N	12	TMDSTX2P
13	Ground	14	TMDSTXCN
15	TMDSTXCP	16	Ground
17	DVI_DA	18	DVI_SL
19	AUXN	20	AUXP

2.10 <Onboard Audio Interface>

The board provides the onboard high definition audio with Realtek ALC888

Connector: CN_AUDIO

Type: 10-pin (2 x 5) 1.27mm x 2.54mm-pitch header

Pin	Description	Pin	Description
1	MIC2_L	2	AGND
3	MIC2_R	4	AVCC
5	FRO_R	6	MIC2_JD
7	F_IO_SEN	8	N/C
9	FRO_L	10	LINE2_JD

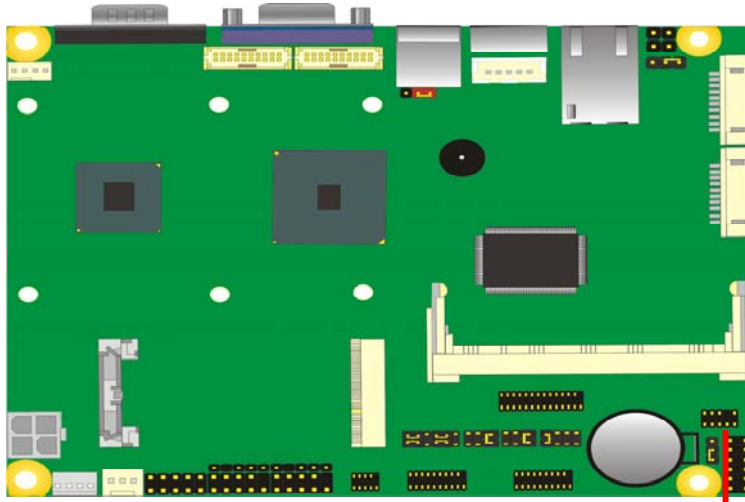

CN_AUDIO

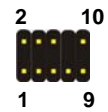

2.11 <USB2.0 Interface>

Based on AMD A55E FCH, the board provides 6 USB2.0 ports. The USB2.0 interface provides up to 480Mbps of transferring rate.

Interface	USB2.0
Controller	A55E
Transfer Rate	Up to 480Mb/s
Output Current	500mA

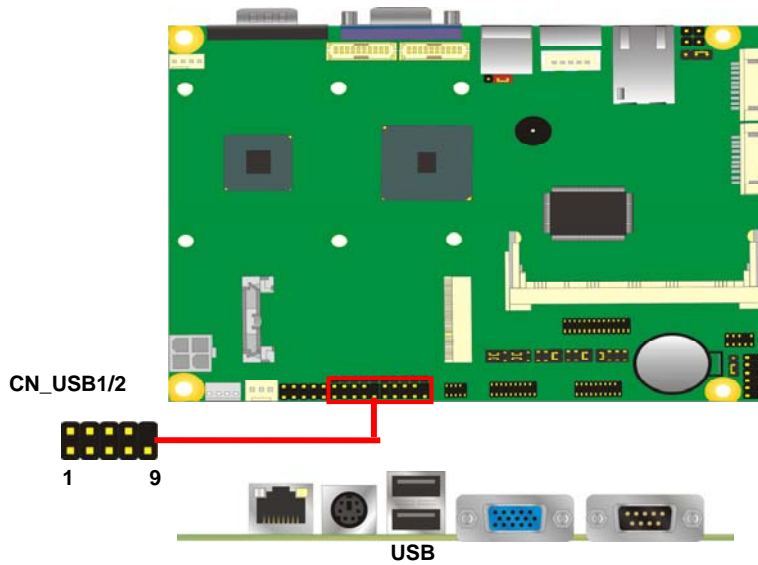

Connector: **CN_USB**

Type: 10-pin (5 x 2) header for USB Port

Pin	Description	Pin	Description
1	VCC	2	VCC
3	D0-	4	D1-
5	D0+	6	D1+
7	Ground	8	Ground
9	Ground	10	N/C

PS: The USB2.0 will be only active when you connecting with the USB2.0 devices, if you insert an USB1.1 device, the port will be changed to USB1.1 protocol automatically. The transferring rate of USB2.0 as 480Mbps is depends on device capacity, exact transferring rate may not be up to 480Mbps.

2.12 <GPIO Interface>

The board provides a programmable 8-bit digital I/O interface; you can use this general purpose I/O port for system control like POS or KIOSK.

Connector: **CN_DIO**

Type: onboard 2 x 6-pin header, pitch=2.0mm

Pin	Description	Pin	Description
1	Ground	2	Ground
3	GP10	4	GP14
5	GP11	6	GP15
7	GP12	8	GP16
9	GP13	10	GP17
11	+5V	12	+12V

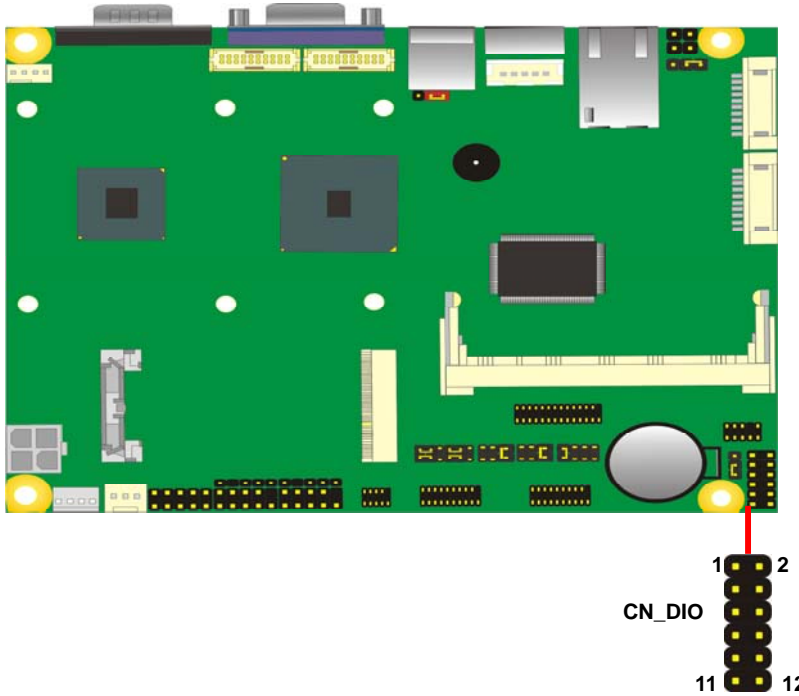

2.13 <Serial Port Jumper Setting >

The board provides two RS232 serial ports, with jumper selectable RS422/485/IrDA for COM2.

Connector: **CN_COM2**

Type: 10-pin (5 x 2) 1.27mm x 2.54mm-pitch header for COM2

Pin	Description	Pin	Description
1	DCD/422TX-/485-	2	SINBTXC
3	SOUTBRXC	4	DTRBRXC-
5	GND	6	MDSR2-
7	MRTS2-	8	MCTS2-
9	MRI2-	10	N/C

Jumper: **JCSEL1,JCSEL2**

Type: 12-pin (6 x 2) & 8-pin (4 x 2) for set COM2 mode jumper

	RS232	RS485	RS422	IrDA
JCSEL1				
JCSEL2				

Default: RS232

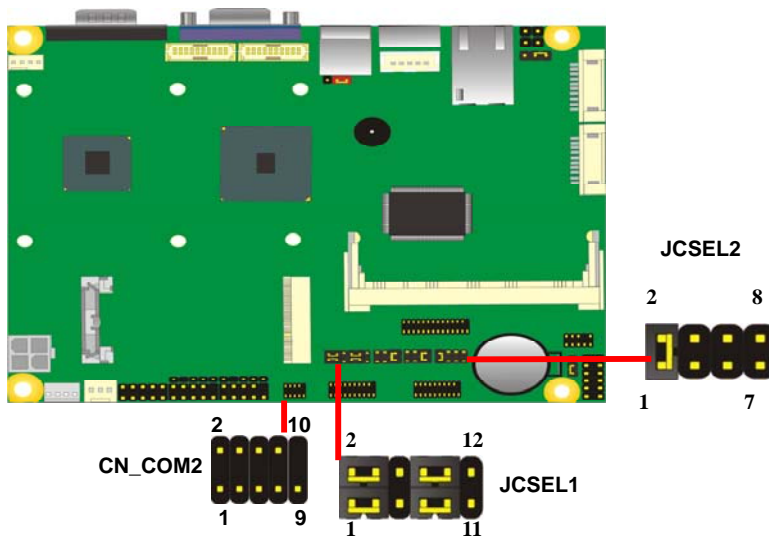

2.14 <Power & FAN Connector >

The board requires DC input with 4-pin header, the input voltage range is from 5V to 24V, for the input current, please take a reference of the power consumption report on appendix.

2.14.1 <Power Input>

Connector: DC_IN

Type: 4-pin header

Pin	Description	Pin	Description
1	Ground	4	+12V
2	Ground	3	+12V

Remark: DC input voltage range 9~24V

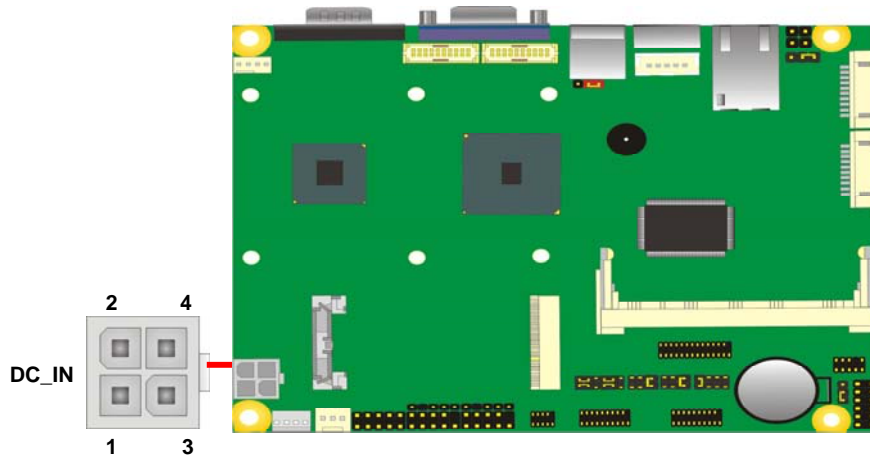

2.14.2 <Power Output>

Connector: **DC_OUT**

Type: 4-pin connector for +5V/+12V **output**

Pin	Description	Pin	Description	Pin	Description	Pin	Description
1	+12V	2	Ground	3	Ground	4	+5V

Note: Maximum output current 12V/1A, 5V/1A

2.14.3 <Fan Connector>

Connector: **SYSFAN**

Type: 3-pin fan wafer connector

Pin	Description	Pin	Description	Pin	Description
1	Ground	2	+12V	3	CSFAN

Connector: **CPUFAN**

Type: 4-pin fan wafer connector

Pin	Description
1	Ground
2	+12V
3	Fan Speed Detection
4	Fan Control

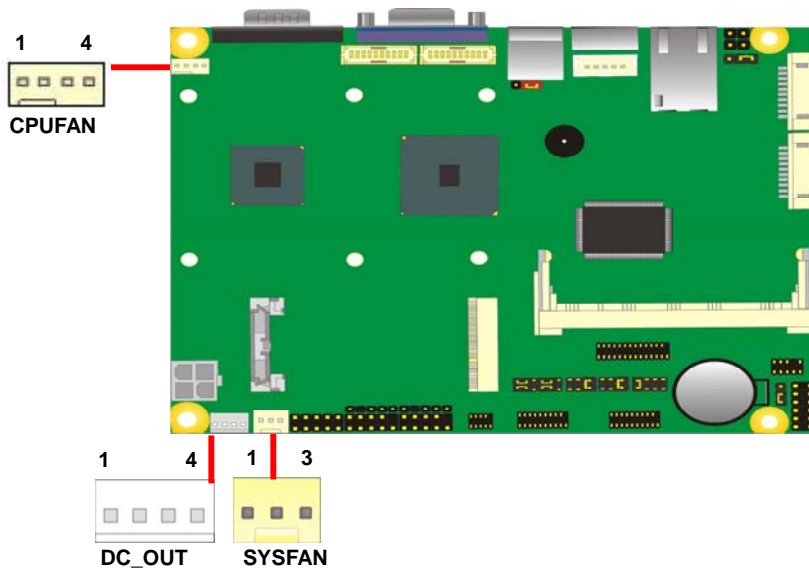

2.15 <Indicator and Switch>

The **JFRNT** provides front control panel of the board, such as power button, reset and beeper, etc. Please check well before you connecting the cables on the chassis.

Connector: **JFRNT**

Type: onboard 10-pin (2 x 5) 2.54-pitch header

Function	Signal	PIN		Signal
Power	PWRBT-	1	2	PWRBT+
Speaker	SPK-	3	4	SPK+
HDD LED	HLED-	5	6	HLED+
Power LED	GND	7	8	PWLED+
Reset	Reset-	9	10	GND

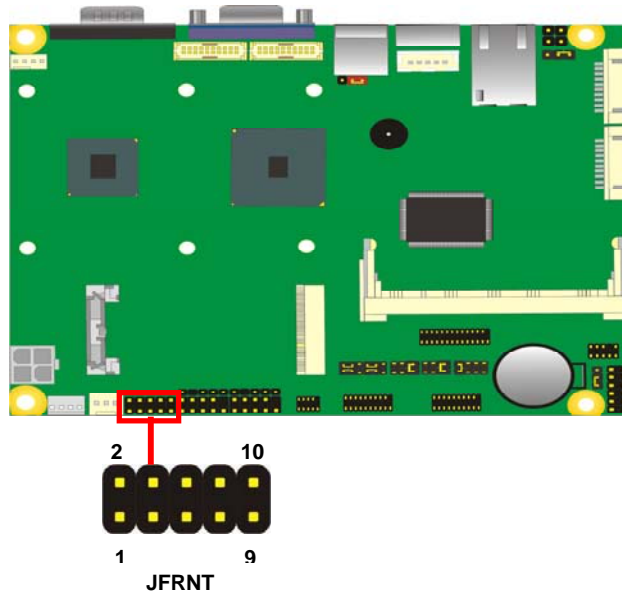

(This Page is Left For Blank)

Chapter 3 <BIOS Setup>

The motherboard uses the Award BIOS for the system configuration. The Award BIOS in the single board computer is a customized version of the industrial standard BIOS for IBM PC AT-compatible computers. It supports Intel® x86 and compatible CPU architecture based processors and computers. The BIOS provides critical low-level support for the system central processing, memory and I/O sub-systems.

The BIOS setup program of the single board computer let the customers modify the basic configuration setting. The settings are stored in a dedicated battery-backed memory, NVRAM, retains the information when the power is turned off. If the battery runs out of the power, then the settings of BIOS will come back to the default setting.

The BIOS section of the manual is subject to change without notice and is provided here for reference purpose only. The settings and configurations of the BIOS are current at the time of print, and therefore they may not be exactly the same as that displayed on your screen.

To activate CMOS Setup program, press key immediately after you turn on the system. The following message "Press DEL to enter SETUP" should appear in the lower left hand corner of your screen. When you enter the CMOS Setup Utility, the Main Menu will be displayed as **Figure 4-1**. You can use arrow keys to select your function, press <Enter> key to accept the selection and enter the sub-menu.

Figure 4-1 CMOS Setup Utility Main Screen



(This Page is Left for Blank)

Appendix A <I/O Port Pin Assignment>

A.1 <SATA Port>

Connector: **SATA1/2**

Type: 10-pin header for SATA Port

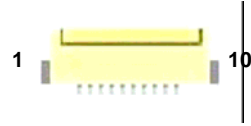

Pin	Description	Pin	Description
1	Ground	2	TXP
3	TXN	4	Ground
5	N/C	6	N/C
7	Ground	8	RXN
9	RXP	10	Ground

A.2 <IrDA Port>

Connector: **CN_IR**

Type: 5-pin header for SIR Port



Pin	Description
1	VCC
2	N/C
3	IRRX
4	Ground
5	IRTX

A.3 <SMBUS Port>

Connector: **CN_SMBUS**

Type: 5-pin header for SMBUS Port



Pin	Description
1	VCC
2	N/C
3	SMDATA
4	SMCLK
5	Ground

A.4 <LPT Port>

Connector: CN_LPT

Type: 26-pin header for LPT Port

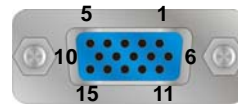

Pin	Description		
1	-PSTB	14	AFD-
2	PRD0	15	ERR-
3	PRD1	16	INIT-
4	PRD2	17	SLIN-
5	PRD3	18	GND
6	PRD4	19	GND
7	PRD5	20	GND
8	PRD6	21	GND
9	PRD7	22	GND
10	ACK-	23	GND
11	BUSY	24	GND
12	PE	25	GND
13	SLCT	26	N/C

A.5 < CRT Port >

Connector: CRT

Type: 15-pin D-sub female connector on rear panel

Pin	Description	Pin	Description	Pin	Description
1	RED	6	Ground	11	N/C
2	GREEN	7	Ground	12	5VCDA
3	BLUE	8	Ground	13	HSYNC
4	N/C	9	LVGA5V	14	VSYNC
5	Ground	10	Ground	15	5VCLK

A.6 <Serial Port>

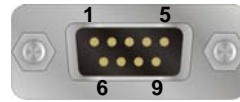

Connector: **COM1**

Type: 9-pin D-sub male connector on rear panel

Pin	Description	Pin	Description
1	DCD	6	DSR
2	SIN	7	RTS
3	SO	8	CTS
4	DTR	9	RI
5	Ground		

A.7 <LAN Port>

Connector: **RJ45**

Type: RJ45 connector with LED on rear panel

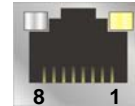

Pin	1	2	3	4	5	6	7	8
Description	TRD0+	TRD0-	TRD1+	TRD2+	TRD2-	TRD1-	TRD3+	TRD3-

A.8 <LAN LED Port>

Connector: **JSPD1**

Type: 2-pin header for LAN Speed LED connector RJ45 connector with LED on rear panel

When Lan speed 10/100Mbps

Pin	Description
1	LED-
2	LED+

When Lan speed 1Gbps

Pin	Description
1	LED+
2	LED-

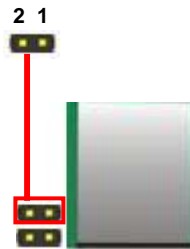

Connector: **JACT**
Type: 5-pin header for LAN Activity LED connector

Pin	Description
1	LED-
2	LED+

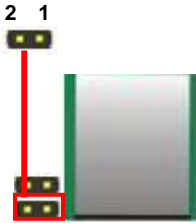

Appendix B <Flash BIOS>

B.1 BIOS Auto Flash Tool

The board is based on Award BIOS and can be updated easily by the BIOS auto flash tool. You can download the tool online at the address below:

<http://www.phoenix.com/en/home/>

http://www.commell.com.tw/Support/Support_SBC.htm

File name of the tool is "Pflash.exe", it's the utility that can write the data into the BIOS flash chip and update the BIOS.

B.2 Flash Method

































1. Please make a bootable floppy disk.
2. Get the last .bin files you want to update and copy it into the disk.
3. Copy awardflash.exe to the disk.
4. Power on the system and flash the BIOS.
(Example: C:/Pflash /sa /bbl /cvar XXX.bin)
5. Re-start the system.































Any question about the BIOS re-flash please contact your distributors or visit the web-site at below:

<http://www.commell.com.tw/support/support.htm>

Appendix C <System Resources>

C.1 <I/O Port Address Map>

































	[00000000 - 0000001F] Direct memory access controller
	[00000000 - 00000CF7] PCI bus
	[00000020 - 00000021] Programmable interrupt controller
	[00000022 - 00000023] Motherboard resources
	[0000002E - 0000002F] Motherboard resources
	[00000040 - 00000043] System timer
	[00000060 - 00000060] Standard 101/102-Key or Microsoft Natural PS/2 Keyboard
	[00000061 - 00000061] System speaker
	[00000064 - 00000064] Standard 101/102-Key or Microsoft Natural PS/2 Keyboard
	[00000070 - 00000071] System CMOS/real time clock
	[00000072 - 00000073] Motherboard resources
	[00000080 - 00000080] Motherboard resources
	[00000081 - 0000008F] Direct memory access controller
	[00000092 - 00000092] Motherboard resources
	[000000A0 - 000000A1] Programmable interrupt controller
	[000000B0 - 000000B1] Motherboard resources
	[000000B2 - 000000B2] Motherboard resources
	[000000B8 - 000000B8] Motherboard resources
	[000000BC - 000000BC] Motherboard resources
	[000000C0 - 000000DE] Direct memory access controller
	[000000F0 - 000000F0] Motherboard resources
	[000000F0 - 000000FE] Numeric data processor
	[00000170 - 00000177] Secondary IDE Channel
	[000001F0 - 000001F7] Primary IDE Channel
	[00000238 - 0000023F] Communications Port (COM6)
	[00000274 - 00000277] ISAPNP Read Data Port
	[00000279 - 00000279] ISAPNP Read Data Port
	[000002E8 - 000002EF] Communications Port (COM4)
	[000002F8 - 000002FF] Communications Port (COM2)
	[00000338 - 0000033F] Communications Port (COM5)
	[00000376 - 00000376] Secondary IDE Channel
	[00000378 - 0000037F] Printer Port (LPT1)
	[000003B0 - 000003BB] AMD Radeon HD 6300 series Graphics
	[000003C0 - 000003DF] AMD Radeon HD 6300 series Graphics

	[000003E8 - 000003EF]	Communications Port (COM3)
	[000003F6 - 000003F6]	Primary IDE Channel
	[000003F8 - 000003FF]	Communications Port (COM1)
	[0000040B - 0000040B]	Direct memory access controller
	[000004D0 - 000004D1]	Motherboard resources
	[000004D6 - 000004D6]	Direct memory access controller
	[00000530 - 00000537]	Motherboard resources
	[00000800 - 00000827]	Motherboard resources
	[00000830 - 00000830]	Motherboard resources
	[00000840 - 00000847]	Motherboard resources
	[00000A79 - 00000A79]	ISAPNP Read Data Port
	[00000B00 - 00000B1F]	Motherboard resources
	[00000B20 - 00000B3F]	Motherboard resources
	[00000C00 - 00000C01]	Motherboard resources
	[00000C14 - 00000C14]	Motherboard resources
	[00000C50 - 00000C52]	Motherboard resources
	[00000CD0 - 00000CD1]	Motherboard resources
	[00000CD2 - 00000CD3]	Motherboard resources
	[00000CD4 - 00000CD5]	Motherboard resources
	[00000CD6 - 00000CD7]	Motherboard resources
	[00000CD8 - 00000CDF]	Motherboard resources
	[00000CF9 - 00000CF9]	Motherboard resources
	[00000D00 - 0000FFFF]	PCI bus
	[00000F50 - 00000F51]	Motherboard resources
	[00001000 - 0000101F]	Intel(R) 82583V Gigabit Network Connection
	[00001000 - 00001FFF]	PCI standard PCI-to-PCI bridge
	[00002000 - 000020FF]	AMD Radeon HD 6300 series Graphics
	[00002100 - 0000210F]	Standard Dual Channel PCI IDE Controller
	[00008100 - 000081FF]	Motherboard resources
	[00008200 - 000082FF]	Motherboard resources

C.2 <Memory Address Map >

[000A0000 - 000BFFFF]	AMD Radeon HD 6300 series Graphics
[000A0000 - 000BFFFF]	PCI bus
[000C0000 - 000C1FFF]	PCI bus
[000C2000 - 000C3FFF]	PCI bus
[000C4000 - 000C5FFF]	PCI bus
[000C6000 - 000C7FFF]	PCI bus
[000C8000 - 000C9FFF]	PCI bus
[000CA000 - 000CBFFF]	PCI bus
[000CC000 - 000CDFFF]	PCI bus
[000CE000 - 000CFFFF]	PCI bus
[000D0000 - 000D1FFF]	PCI bus
[000D2000 - 000D3FFF]	PCI bus
[000D4000 - 000D5FFF]	PCI bus
[000D6000 - 000D7FFF]	PCI bus
[000D8000 - 000D9FFF]	PCI bus
[000DA000 - 000DBFFF]	PCI bus
[000DC000 - 000DDFFF]	PCI bus
[000DE000 - 000DFFFF]	PCI bus
[000E0000 - 000E1FFF]	PCI bus
[000E0000 - 000FFFFFF]	System board
[000E2000 - 000E3FFF]	PCI bus
[000E4000 - 000E5FFF]	PCI bus
[000E6000 - 000E7FFF]	PCI bus
[000E8000 - 000E9FFF]	PCI bus
[000EA000 - 000EBFFF]	PCI bus
[000EC000 - 000EDFFF]	PCI bus
[000EE000 - 000EFFFF]	PCI bus
[7F000000 - DFFFFFFF]	PCI bus
[80000000 - 8FFFFFFF]	AMD Radeon HD 6300 series Graphics
[90000000 - 907FFFFFFF]	PCI standard PCI-to-PCI bridge
[90800000 - 9081FFFF]	Intel(R) 82583V Gigabit Network Connection
[90800000 - 90FFFFFF]	PCI standard PCI-to-PCI bridge
[90820000 - 90823FFF]	Intel(R) 82583V Gigabit Network Connection
[91000000 - 9103FFFF]	AMD Radeon HD 6300 series Graphics
[91040000 - 91043FFF]	Microsoft UAA Bus Driver for High Definition Audio
[91044000 - 91047FFF]	Microsoft UAA Bus Driver for High Definition Audio
[91048000 - 91048FFF]	Standard OpenHCD USB Host Controller
[91049000 - 91049FFF]	Standard OpenHCD USB Host Controller
[9104A000 - 9104AFFF]	Standard OpenHCD USB Host Controller
[9104B000 - 9104BFFF]	Standard OpenHCD USB Host Controller
[9104C000 - 9104C3FF]	Standard Dual Channel PCI IDE Controller
[9104C400 - 9104C4FF]	Standard Enhanced PCI to USB Host Controller
[9104C500 - 9104C5FF]	Standard Enhanced PCI to USB Host Controller
[9104C600 - 9104C6FF]	Standard Enhanced PCI to USB Host Controller
[E0000000 - E1FFFFFF]	Motherboard resources
[E1000000 - FFFFFFFF]	PCI bus
[FEC00000 - FEC00FFF]	Motherboard resources
[FEC10000 - FEC1001F]	System board
[FED00000 - FED003FF]	System board
[FED61000 - FED613FF]	System board
[FED80000 - FED80FFF]	System board
[FEE00000 - FEE00FFF]	Motherboard resources
[FFE00000 - FFFFFFFF]	System board

C.3 < System IRQ Resources >

	(ISA) 0	System timer
	(ISA) 1	Standard 101/102-Key or Microsoft Natural PS/2 Keyboard
	(ISA) 3	Communications Port (COM2)
	(ISA) 4	Communications Port (COM1)
	(ISA) 8	System CMOS/real time clock
	(ISA) 9	Microsoft ACPI-Compliant System
	(ISA) 11	Communications Port (COM3)
	(ISA) 11	Communications Port (COM4)
	(ISA) 11	Communications Port (COM5)
	(ISA) 11	Communications Port (COM6)
	(ISA) 12	PS/2 Compatible Mouse
	(ISA) 13	Numeric data processor
	(ISA) 14	Primary IDE Channel
	(PCI) 16	Intel(R) 82583V Gigabit Network Connection
	(PCI) 16	Microsoft UAA Bus Driver for High Definition Audio
	(PCI) 16	PCI standard PCI-to-PCI bridge
	(PCI) 16	PCI standard PCI-to-PCI bridge
	(PCI) 16	PCI standard PCI-to-PCI bridge
	(PCI) 16	PCI standard PCI-to-PCI bridge
	(PCI) 16	PCI standard PCI-to-PCI bridge
	(PCI) 17	PCI standard PCI-to-PCI bridge
	(PCI) 17	Standard Enhanced PCI to USB Host Controller
	(PCI) 17	Standard Enhanced PCI to USB Host Controller
	(PCI) 17	Standard Enhanced PCI to USB Host Controller
	(PCI) 18	AMD Radeon HD 6300 series Graphics
	(PCI) 18	PCI standard PCI-to-PCI bridge
	(PCI) 18	Standard OpenHCD USB Host Controller
	(PCI) 18	Standard OpenHCD USB Host Controller
	(PCI) 18	Standard OpenHCD USB Host Controller
	(PCI) 18	Standard OpenHCD USB Host Controller
	(PCI) 19	Microsoft UAA Bus Driver for High Definition Audio
	(PCI) 19	PCI standard PCI-to-PCI bridge

Appendix D <Programming GPIO's>

The GPIO can be programmed with the MS-DOS debug program using simple IN/OUT commands. The following lines show an example how to do this.

```
GPIO0.....GPIO7  bit0.....bit7
-o 2E 87           ;enter configuration.
-o 2E 87
-o 2E 07
-o 2F 09           ;select logic device 9.
-o 2E 30
-o 2F 02           ;active GPIO3.
-o 2E F0
-o 2F xx           ;set GPIO as input/output; set '1' for input,'0'for
                   output.
-o 2E F1
-o 2F xx           ;if set GPIO's as output,in this register its value
                   can be set
```

Optional :

```
-o 2E F2
-o 2F xx           ; Data inversion register ; '1' inverts the current
                   valus of the bits ,'0' leaves them as they are
```

For further information, please refer to Winbond W83627DHG-P datasheet.

Appendix E <Watch Dog timer Setting >

The watchdog timer makes the system auto-reset while it stops to work for a period. The integrated watchdog timer can be setup as system reset mode by program.

Timeout Value Range

- 1 to 255
- Second or Minute

Program Sample

Watchdog timer setup as system reset with 5 second of timeout

2E, 87	
2E, 87	
2E, 07	
2F, 08	Logical Device 8
2E, 30	
2F, 01	Activate
2E, F5	
2F, 02	Set as Second*
2E, F6	
2F, 05	Set as 5

* Minute: bit 3 = 1; Second: bit 3 = 0

You can select Timer setting in the BIOS, after setting the time options, the system will reset according to the period of your selection.

Appendix F <AMD Hing Definition Audio Device >

1. Copy the CD Driver folder to disk, Ex: C:\ , D:\ ...
2. Please choose "Device Manager"
3. You can see other devices "Audio Device on High Definition Audio Bus"

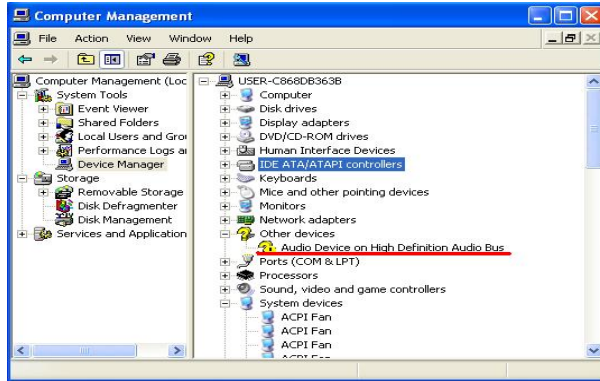

4. Please choose "Audio Device on High Definition Audio Bus" then press Update Driver
5. Please choose "NO, not this time"
6. Install software for "Audio Device on High Definition Audio Bus" Please choose "Install from a list or specific location"
7. Please choose "Search for the best driver in these location" Check "Include this location in the search" then press "Browse"
8. Please select the file location "D:\LE-380\Audio(XP)\XP"

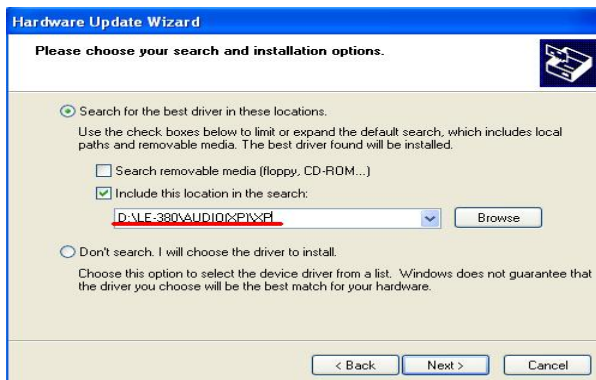

9. Install finish

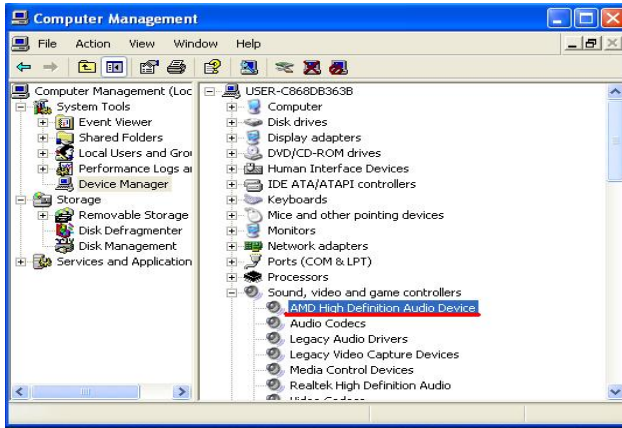

(This Page is Left for Blank)

Contact Information

Any advice or comment about our products and service, or anything we can help you please don't hesitate to contact with us. We will do our best to support you for your products, projects and business.

Taiwan Commate Computer Inc.

Address	19F., No.94, Sec. 1, Xintai 5th Rd., Xizhi Dist., New Taipei City 22102, Taiwan
TEL	+886-2-26963909
FAX	+886-2-26963911
Website	http://www.commell.com.tw
E-Mail	info@commell.com.tw (General Information) tech@commell.com.tw (Technical Support)

Commell is our trademark of industrial PC division