

# LE-374

---

3.5 inch Miniboard

## User's Manual

Edition 1.1

2008/12/12

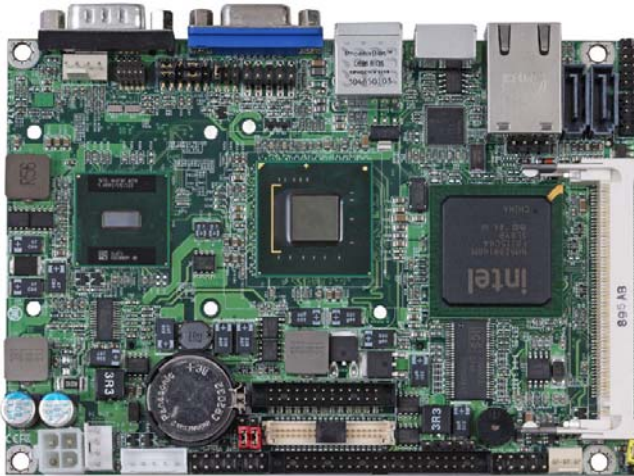

## **Copyright**

Copyright 2008. All rights reserved. This document is copyrighted and all rights are reserved. The information in this document is subject to change without prior notice to make improvements to the products.

This document contains proprietary information and protected by copyright. No part of this document may be reproduced, copied, or translated in any form or any means without prior written permission of the manufacturer.

All trademarks and/or registered trademarks contains in this document are property of their respective owners.

## **Disclaimer**

The company shall not be liable for any incidental or consequential damages resulting from the performance or use of this product.

The company does not issue a warranty of any kind, express or implied, including without limitation implied warranties of merchantability or fitness for a particular purpose.

The company has the right to revise the manual or include changes in the specifications of the product described within it at any time without notice and without obligation to notify any person of such revision or changes.

## **Trademark**

All trademarks are the property of their respective holders.

---

Any questions please visit our website at <http://www.commell.com.tw>

## Packing List

Please check the package before you starting setup the system

### Hardware:

LE-374 Miniboard x 1

### Cable Kit:

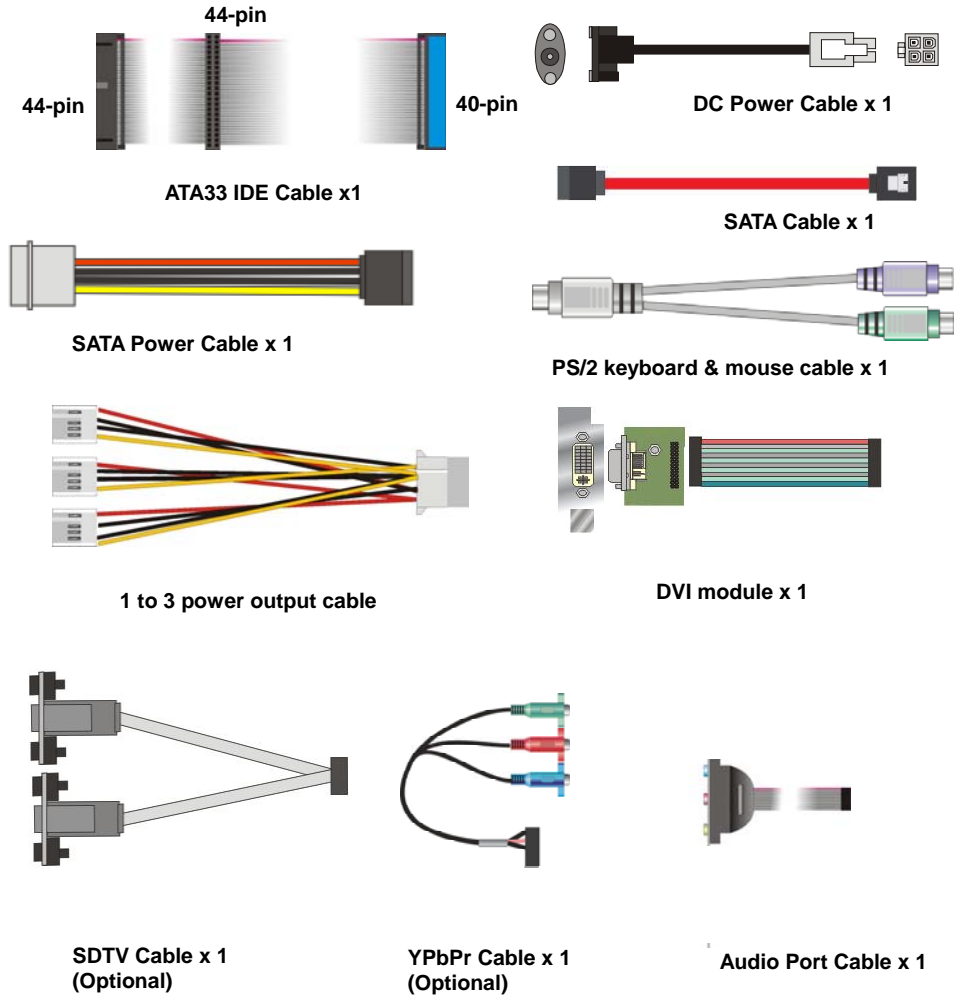

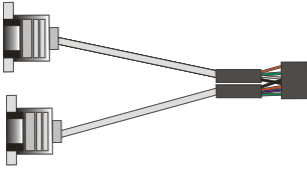

**USB Cable x 1**



**COM Port Cable x 1**

**Printed Matters:**

**Driver CD x 1 (Including User's Manual)**

## Index

<b>Chapter 1 &lt;Introduction&gt;</b> .....	<b>8</b>
1.1 <Product Overview>.....	8
1.2 <Product Specification> .....	9
1.3 <Mechanical Drawing>.....	11
1.4 <Block Diagram>.....	12
<b>Chapter 2 &lt;Hardware Setup&gt;</b> .....	<b>13</b>
2.1 <Connector Location>.....	13
2.2 <Jumper Reference> .....	15
2.3 <Connector Reference>.....	16
2.3.1 <Internal Connector>.....	16
2.3.2 <External Connector>.....	16
2.4 <CPU and Memory Setup> .....	17
2.5 <CMOS & ATX Setup> .....	18
2.6 <Enhanced IDE & CF Interface>.....	19
2.7 <Serial ATA Interface>.....	20
2.7 <Serial ATA Interface>.....	21
2.9.1 <Analog VGA Interface> .....	23
2.9.2 <Digital Display>.....	24
2.9.3 <DVI Interface > .....	27
2.9.4 <TV-out Interface>.....	28
2.10 <Onboard Audio Interface>.....	30
2.11 <USB2.0 Interface>.....	31
2.12 <GPIO Interface> .....	33
2.13 <Serial Port Jumper Setting > .....	34
2.14.1 <Power Input> .....	36
2.14.2 <Power Output> .....	37
2.14.3 <Fan Connector>.....	37
2.15 <Indicator and Switch>.....	37

<b>Chapter 3 &lt;System Configuration&gt;</b> .....	<b>40</b>
3.1 <Video Memory Setup> .....	40
<b>Chapter 4 &lt;BIOS Setup&gt;</b> .....	<b>44</b>
<b>Appendix A &lt;I/O Port Pin Assignment&gt;</b> .....	<b>46</b>
A.1 <IDE Port> .....	46
A.2 <IrDA Port> .....	47
A.3 < CRT Port > .....	47
A.4 <Serial ATA Port> .....	47
A.5 <Serial Port> .....	48
A.6 <LAN Port> .....	48
<b>Appendix B &lt;Flash BIOS&gt;</b> .....	<b>49</b>
B.1 BIOS Auto Flash Tool .....	49
B.2 Flash Method .....	49
<b>Appendix C &lt;System Resources&gt;</b> .....	<b>50</b>
<b>Appendix D &lt;Programming GPIO's&gt;</b> .....	<b>54</b>
<b>Appendix E &lt;Watch Dog timer Setting &gt;</b> .....	<b>55</b>
<b>Contact Information</b> .....	<b>57</b>

**(The Page is Left For Blank)**

## Chapter 1 <Introduction>

### 1.1 <Product Overview>

LE-374 is the 3.5 inch miniboard, with Intel® Atom N270 processor for 533 MHz front side bus, Intel® 945GSE and ICH7M chipset, integrated GMA950 graphics, DDR2 SO-DIMM memory, Realtek AC97 Audio, Serial ATA and one Intel® 82574L Gigabit LAN.

#### Intel Atom Processor

The Intel® Atom N270 single core processor is with 533 MHz front side bus, 512KB L2 cache. It's built on 45nm process technology support Hyper-Threading Technology, Enhanced Intel SpeedStep® Technology reduces average system power consumption.

#### Mobile Intel® 945GSE chipset

The board integrates Intel® 945GSE and ICH7M chipset. The chipset features power-efficient graphics with an integrated 32-bit 3D graphics engine based on Intel® Graphics Media Accelerator 950 architecture with DVI, LVDS, CRT, and TV-Out display ports. It provides I/O capabilities and flexibility via high-bandwidth interfaces such as PCI, Serial ATA and Hi-Speed USB 2.0 connectivity. It also includes a single channel for 400/533 MHz DDR2 system memory (SODIMM), AC97 Audio with 5.1 channels surrounding sound.

#### All in One multimedia solution

Based on Intel 945GSE and ICH7M chipset, the board provides high performance onboard graphics, 18-bit Dual channel LVDS interface, DVI and HDTV and 5.1 channels AC97 Audio, to meet the every requirement of the multimedia application.

#### Flexible Extension Interface

The board also provides Compact Flash Type II socket and one mini-PCI socket.



## 1.2 <Product Specification>

### General Specification

Form Factor	3.5 inch miniboard
CPU	Intel® Atom N270 processor Package type: FCBGA8 Front side bus: 533MHz
Memory	1 x 200-pin DDR2 SO-DIMM SDRAM up to 2GB Unbuffered, none-ECC memory supported only
Chipset	Intel® 945GSE and ICH7M
BIOS	Phoenix-Award v6.00PG 8Mb SPI flash BIOS
Green Function	Power saving mode includes doze, standby and suspend modes. ACPI version 1.0 and APM version 1.2 compliant
Watchdog Timer	System reset programmable watchdog timer with 1 ~ 255 sec./min. of timeout value
Real Time Clock	Intel® ICH7M built-in RTC with lithium battery
Enhanced IDE	UltraDMA33 IDE interface supports up to 2 ATAPI devices One 44-pin IDE port onboard One CompactFlash Type II socket on solder side
Serial ATA	Intel® ICH7M integrates 2 Serial ATA interfaces (No RAID Function) Up to 150MB/s of transfer rate

### Multi-I/O Port

Chipset	Intel® ICH7M with Winbond® W83627THG controller
Serial Port	One RS-232/422/485 serial port and one RS-232
USB Port	Two external & two internal Hi-Speed USB 2.0 ports with 480Mbps of transfer rate
IrDA Port	One IrDA compliant Infrared interface supports SIR
K/B & Mouse	PS/2 keyboard and mouse port
GPIO	One 12-pin Digital I/O connector with 8-bit programmable I/O interface
Smart Fan	One CPU fan connectors for fan speed controllable

### VGA Display Interface

Chipset	Intel® 945GSE GMCH (Graphic Memory Controller Hub)
Frame Buffer	Up to 224MB shared with system memory
Display Type	CRT, LCD monitor with analog display, DVI, HDTV
Connector	External DB15 female connector on rear I/O panel Onboard 40-Pin LVDS connector Onboard 26-Pin DVI connector Onboard 10-Pin TV-out connector

### Ethernet Interface

Controller	1 x Intel 82574L Gigabit Ethernet controller
------------	--

Type	Triple speed 10/100/1000Base-T auto-switching Fast Ethernet Full duplex, IEEE802.3U compliant
Connector	One External RJ45 connector with LED on rear I/O panel

### Audio Interface

Chipset	REALTEK ALC655
Interface	5.1 channel surround audio with Line-in, Line-out and MIC-in
Connector	Onboard audio connector with pin header Onboard CD-IN connector

### Expansive Interface

Mini PCI	1 x Mini PCI socket
----------	---------------------

### Power and Environment

Power Requirement	DC 9~24V input with onboard 4-pin connector
Dimension	146.5 (L) x 101(H) mm
Temperature	Operating within 0 ~ 60°C Storage within -20 ~ 85°C

### Ordering Code

<b>LE-374</b>	Support Intel Atom N270 processor with onboard VGA, HDTV, DVI, LVDS, Audio, SATA, Giga LAN, USB2.0, CF, GPIO, Mini PCI, FDD
---------------	---

---

The specifications may be different as the actual production.

For further product information please visit the website at <http://www.commell.com.tw>

## 1.3 &lt;Mechanical Drawing&gt;

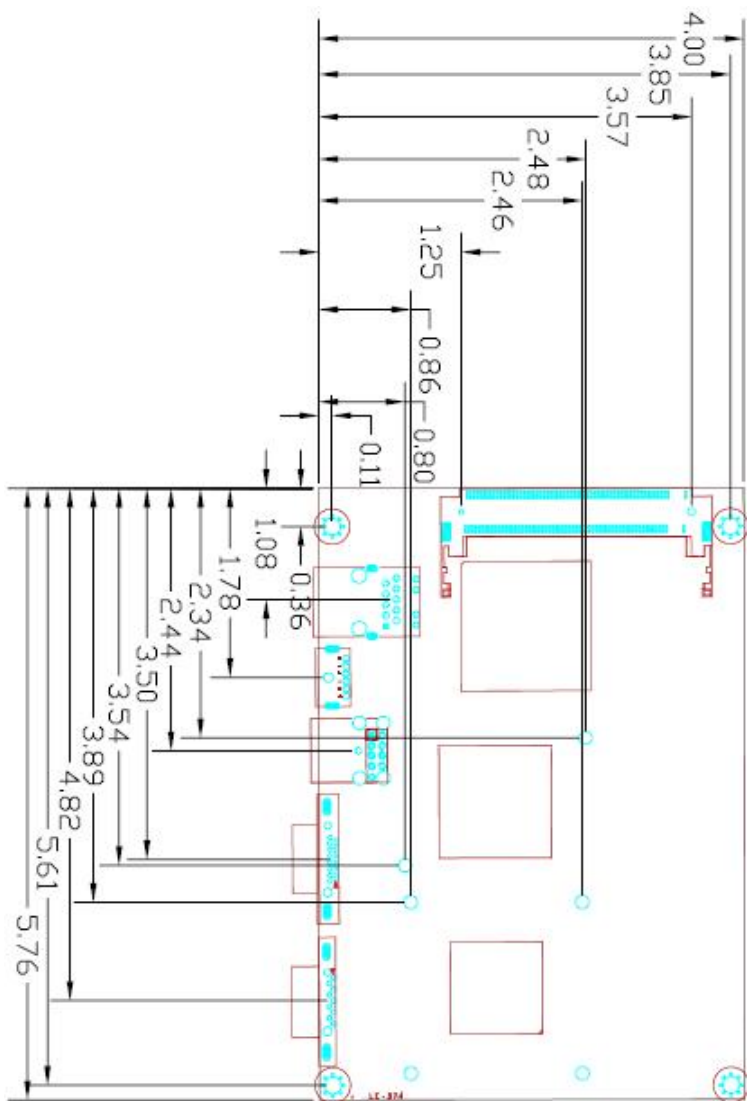

Unit: inch

### 1.4 <Block Diagram>

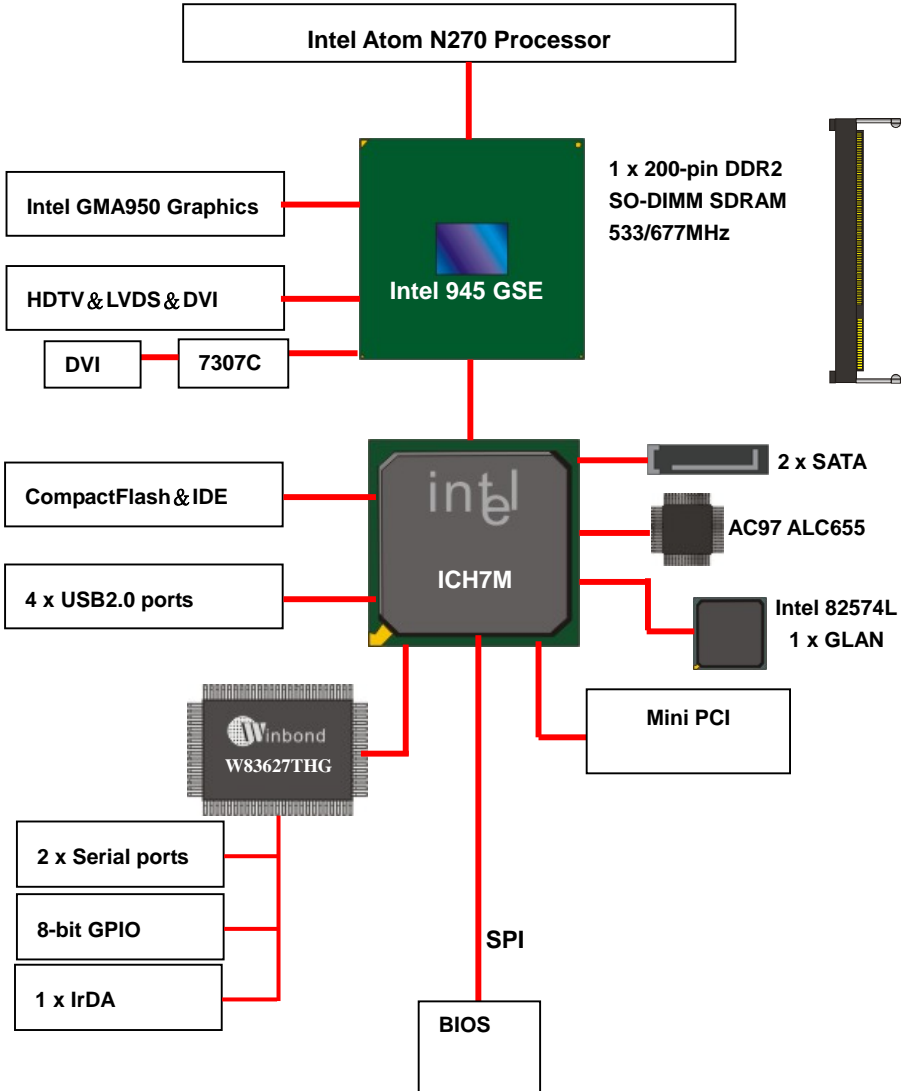

## Chapter 2 <Hardware Setup>

### 2.1 <Connector Location>

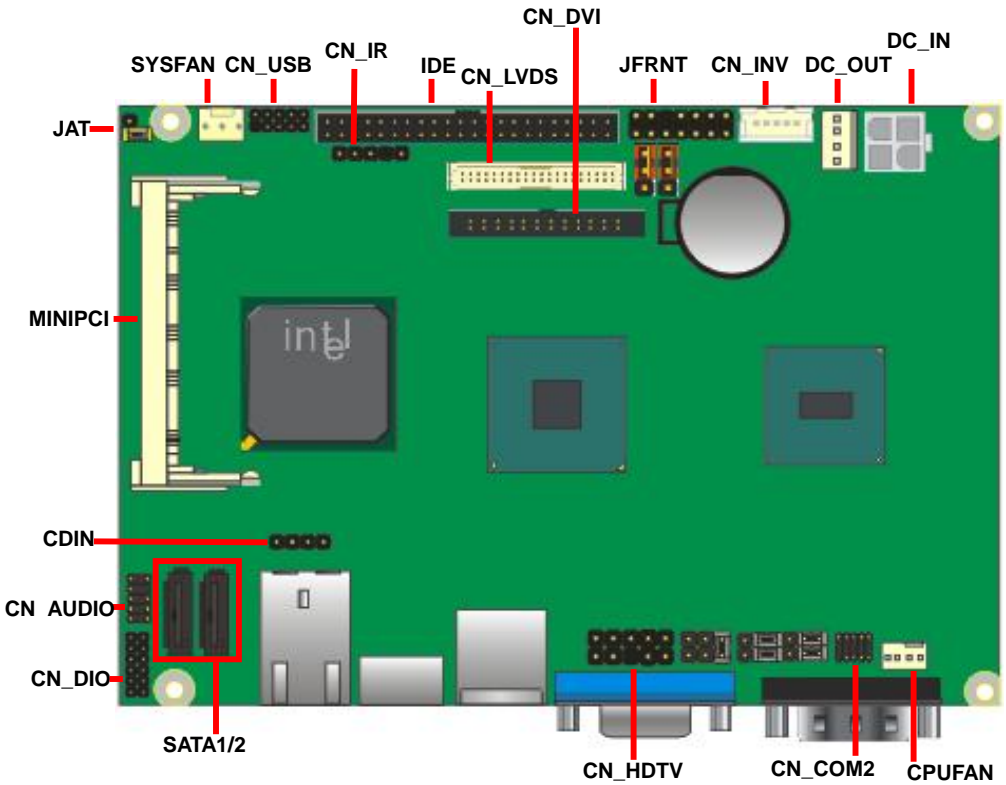

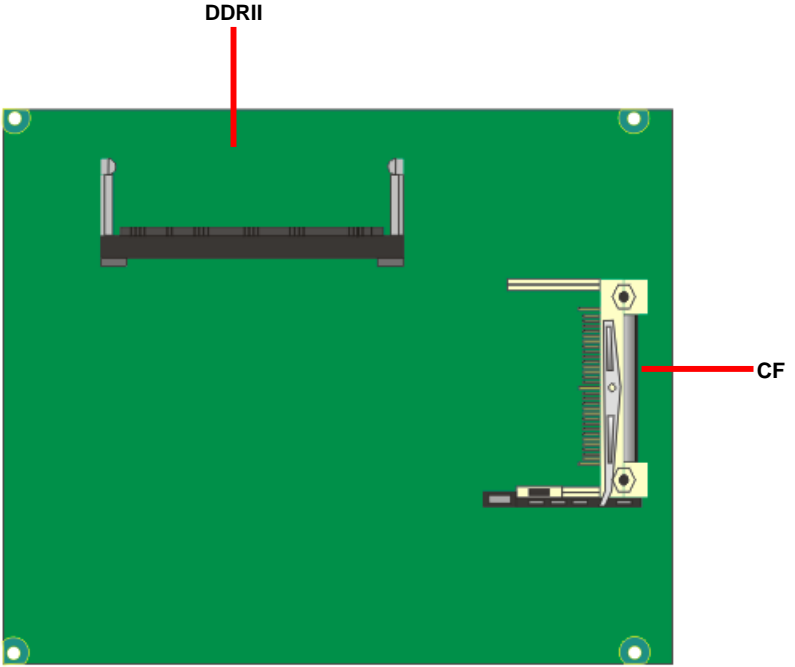

## 2.2 <Jumper Reference>

Jumper	Function
JRTC	CMOS Operating/Clear Setting
JVLCD	LCD Panel Voltage Setting
JAT	AT Mode
JCSEL1/2	COM2 RS232/422/485 mode setting

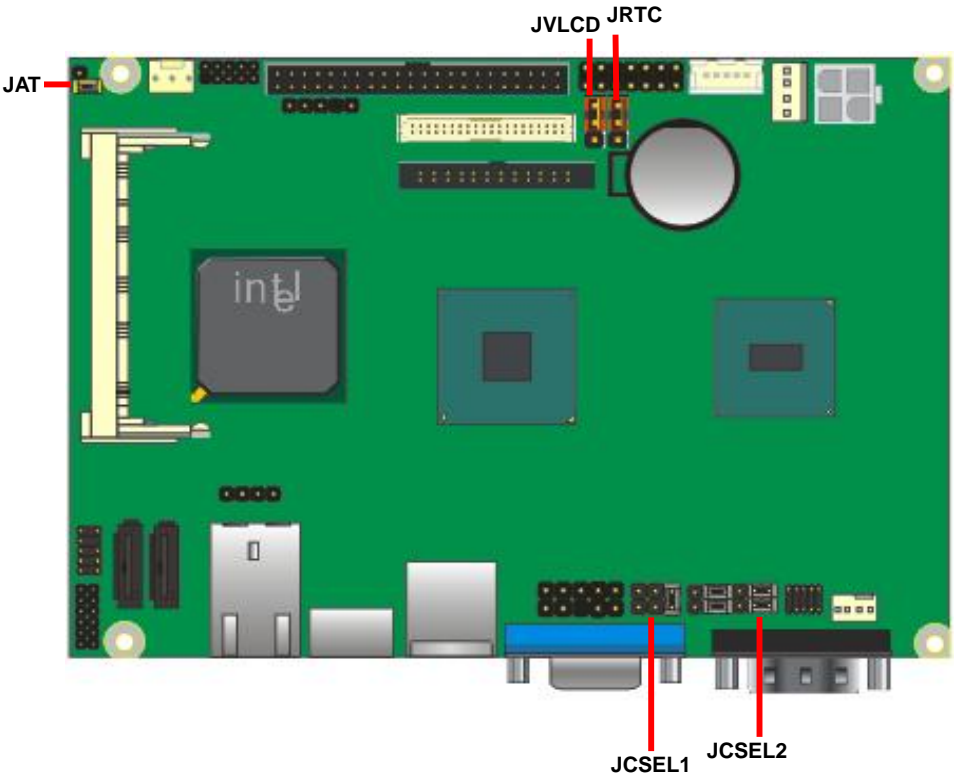

## 2.3 <Connector Reference>

### 2.3.1 <Internal Connector>

Connector	Function	Remark
DDRII	200 -pin DDR2 SO-DIMM SDRAM slot	Standard
IDE	44-pin primary IDE connector	Slim
SATA1/2	7-pin Serial ATA connector	Standard
CN_AUDIO	5 x 2-pin audio connector	Slim
CDIN	4-pin CD-ROM audio input connector	Standard
CN_DIO	6 x 2-pin digital I/O connector	Standard
CN_USB	5 x 2-pin USB connector	Standard
CPUFAN	4-pin CPU cooler fan connector	Standard
SYSFAN	3-pin system cooler fan connector	Standard
CN_COM2	5 x 2-pin com connector	Slim
CN_IR	5-pin IrDA connector	Standard
CF	Compact Flash Type II socket	Standard
CN_LVDS	20 x 2-pin LVDS connector	Standard
CN_INV	5-pin LCD inverter connector	Standard
DC_OUT	4-pin power output connector	Standard
DC_IN	DC 12V input connector	Standard
MINIPCI	Mini-PCI socket	Standard
CN_DVI	13 x 2-pin DVI interface	Standard
CN_HDTV	5 x 2-pin HDTV interface	Standard
JFRNT	14-pin switch/indicator connector	Standard

### 2.3.2 <External Connector>

Connector	Function	Remark
CRT	DB15 VGA connector	Standard
USB	Dual USB 2.0 connector	Standard
COM1	DB9 Serial port connector	Standard
RJ45	One RJ45 LAN connector	Standard
PS2	PS/2 keyboard and mouse connector	Standard



## 2.4 <CPU and Memory Setup>

The board provides one 200-pin DDR2 SO-DIMM to support DDR2 533 memory modules up to 2GB of capacity. Non-ECC, unbuffered memory is supported only.

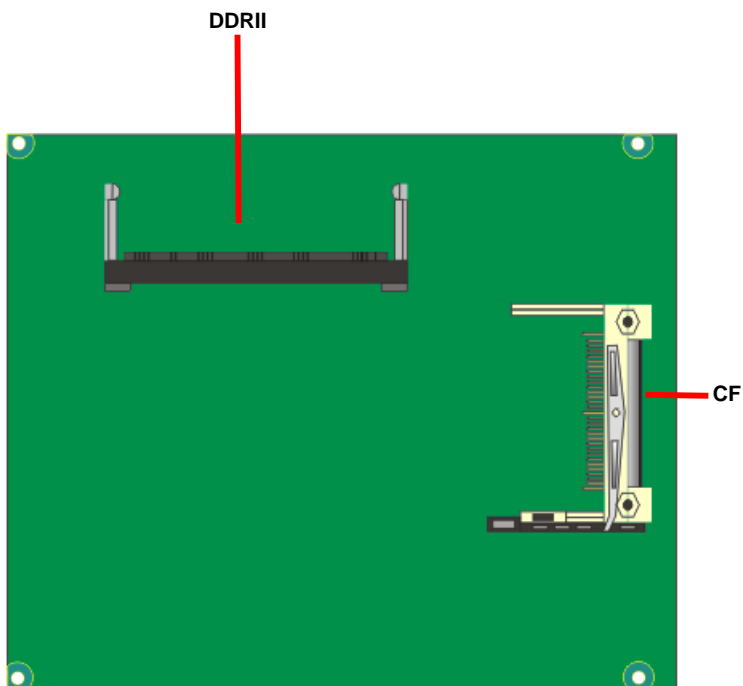

## 2.5 <CMOS & ATX Setup>

The board's data of CMOS can be setting in BIOS. If the board refuses to boot due to inappropriate CMOS settings, here is how to proceed to clear (reset) the CMOS to its default values.

Jumper: **JRTC**

Type: Onboard 3-pin jumper

JRTC	Mode
1-2	Clear CMOS
2-3	Normal Operation
Default setting	

Jumper: **JAT**

Type: onboard 2-pin header

JAT	Mode
Open	ATX Mode
Short	AT Mode
Default setting	

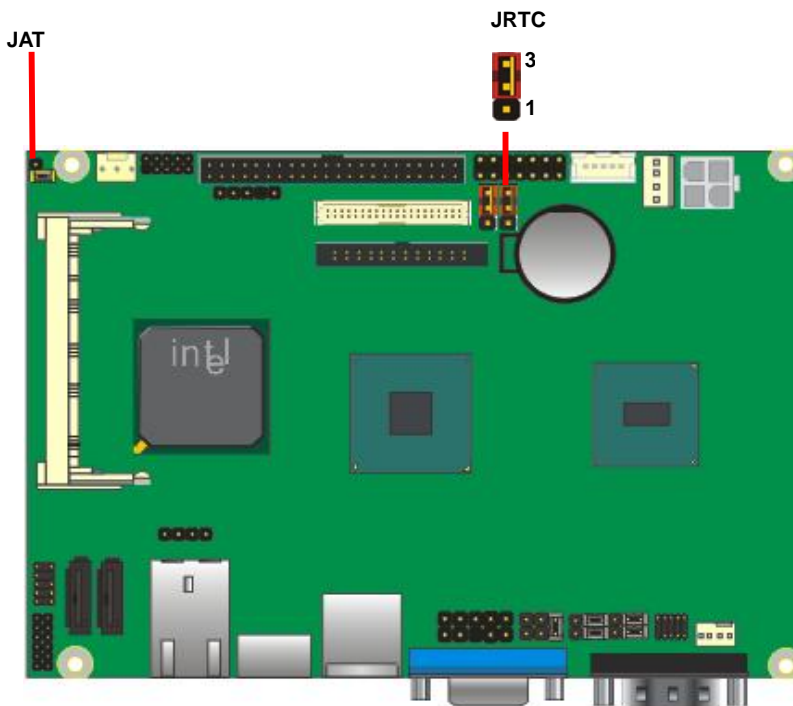

## 2.6 <Enhanced IDE & CF Interface>

The board has one Ultra DMA33 IDE interface to support up to 2 ATAPI devices, and one Compact Flash Type II socket on the solder side.

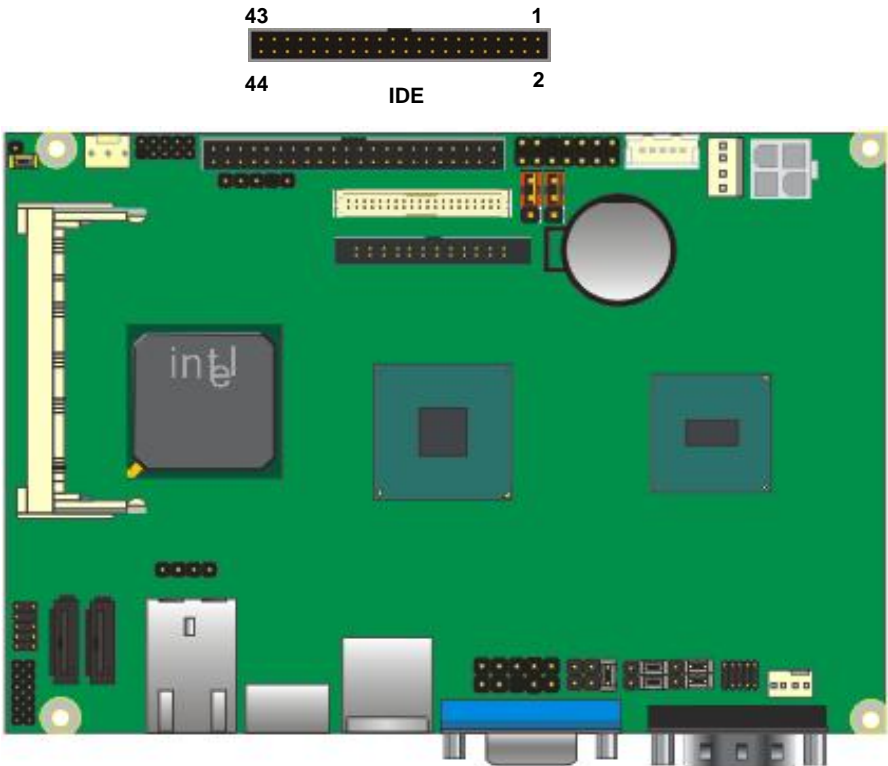

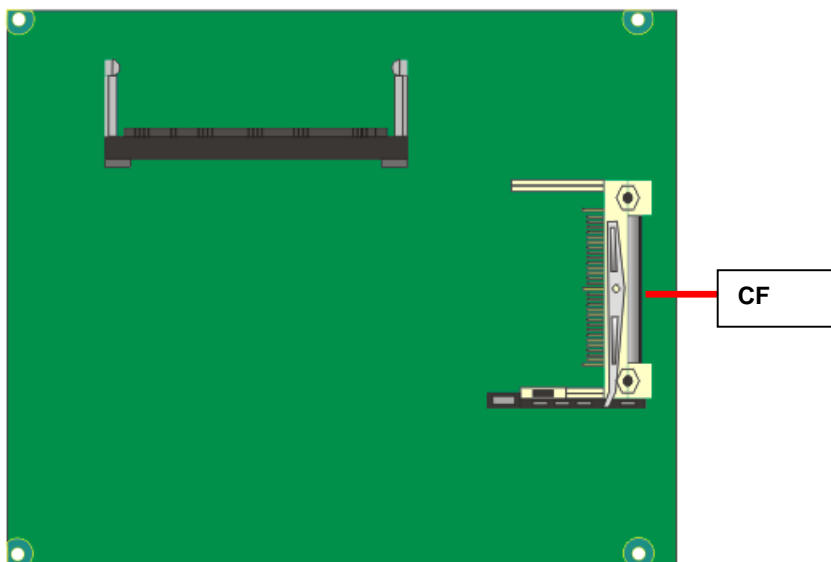

## 2.7 <Serial ATA Interface>

Based on Intel ICH7M, the board provides two Serial ATA interfaces with up to 150MB/s of transfer rate.

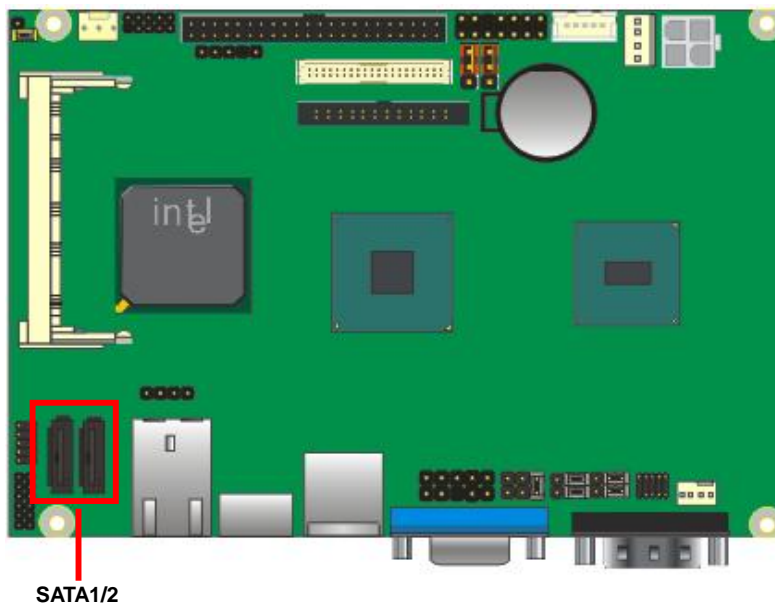

## 2.8 <LAN Interface>

The Intel 82574L supports triple speed of 10/100/1000Base-T, with IEEE802.3 compliance and Wake-On-LAN supported.



## 2.9 <Onboard Display Interface>

Based on Intel 945GSE chipset with built-in GMA (Graphic Media Accelerator) 950 graphics, the board provides one DB15 connector on rear external I/O port, and one 40-pin LVDS interface with 5-pin LCD backlight inverter connector. The board provides dual display function with clone mode and extended desktop mode for CRT and LCD and DVI and TV-out.

### 2.9.1 <Analog VGA Interface>

Please connect your CRT or LCD monitor with DB15 male connector to the onboard DB15 female connector on rear I/O port.

The board supports up to 2048 x 1536 (QXGA) of resolution.



## 2.9.2 <Digital Display>

The board provides one 40-pin LVDS connector for 18-bit dual channel panels, supports up to 1600 x 1200 (UXGA) of resolution, with one LCD backlight inverter connector and one jumper for panel voltage setting

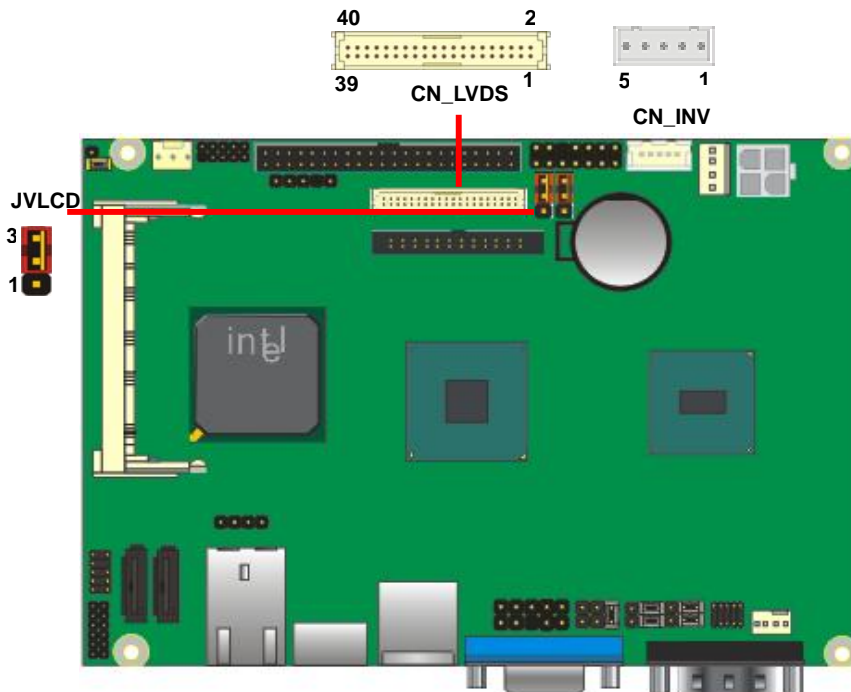



Connector: **CN\_INV**

Type: 5-pin LVDS Power Header

Connector model: **JST B5B-XH-A**

Pin	Description
1	+12V
2	GND
3	GND
4	GND
5	ENABKL

Connector: **JVLCD**

Type: 3-pin Power select Header

Pin	Description
1	VCC(5V)
2	LCDVCC
3	VCC3(3.3)

Connector: **CN\_LVDS**

Type: onboard 40-pin connector for LVDS connector

Connector model: **HIROSE DF13-40DP-1.25V**

Pin	Signal	Pin	Signal
2	LCDVCC	1	LCDVCC
4	GND	3	GND
6	ATX0-	5	BTX0-
8	ATX0+	7	BTX0+
10	GND	9	GND
12	ATX1-	11	BTX1-
14	ATX1+	13	BTX1+
16	GND	15	GND
18	ATX2-	17	BTX2-
20	ATX2+	19	BTX2+
22	GND	21	GND
24	ACLK-	23	N/C
26	ACLK+	25	N/C
28	GND	27	GND
30	N/C	29	BCLK-
32	N/C	31	BCLK+
34	GND	33	GND
36	N/C	35	N/C
38	N/C	37	N/C
40	N/C	39	N/C

To setup the LCD, you need the component below:

1. A panel with LVDS interfaces.
2. An inverter for panel's backlight power.
3. A LCD cable and an inverter cable.

For the cables, please follow the pin assignment of the connector to make a cable, because every panel has its own pin assignment, so we do not provide a standard cable; please find a local cable manufacture to make cables.

### LCD Installation Guide:

1. Preparing the **LE-374, LCD panel** and the **backlight inverter**.

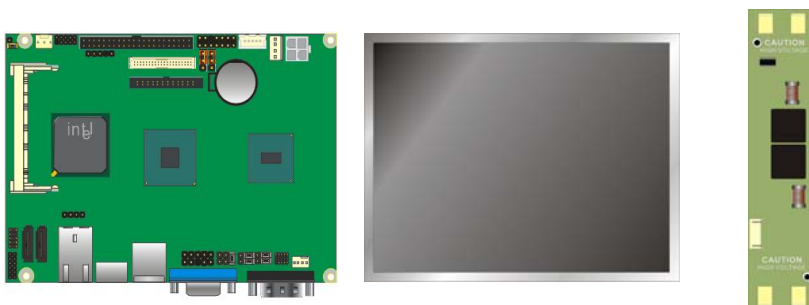

2. Please check the datasheet of the panel to see the voltage of the panel, and set the jumper **JVLCD** to +5V or +3.3V.
3. You would need a LVDS type cable.

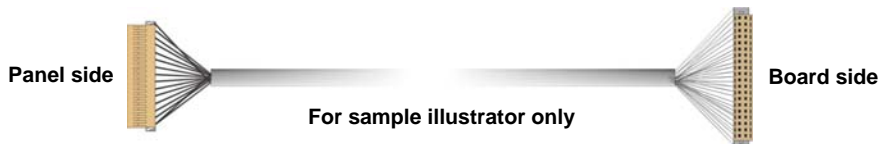

4. To connect all of the devices well.

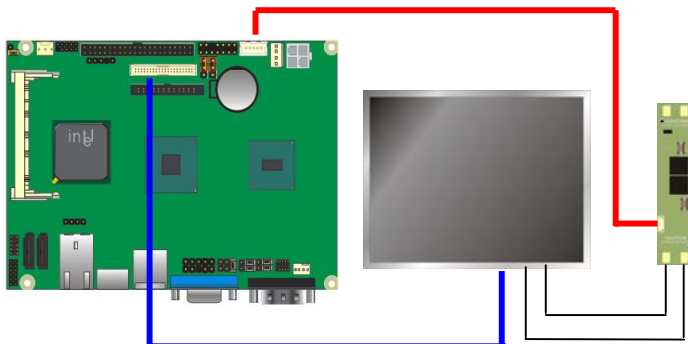

### 2.9.3 <DVI Interface >

The board also comes with a DVI interface with Chrontel CH7307C for digital video interface. Supports up to 1600 x 1200 (UXGA) of resolution.

Connector: **CN\_DVI**

Connector type: 26-pin header connector (pitch = 2.00mm)

Pin Number	Assignment	Pin Number	Assignment
1	TX1+	2	TX1-
3	Ground	4	Ground
5	TXC+	6	TXC-
7	Ground	8	PVDD
9	N/C	10	N/C
11	TX2+	12	TX2-
13	Ground	14	Ground
15	TX0+	16	TX0-
17	N/C	18	HPDET
19	DDCCDATA	20	DDCCCLK
21	GND	22	N/C
23	N/C	24	N/C
25	N/C	26	N/C

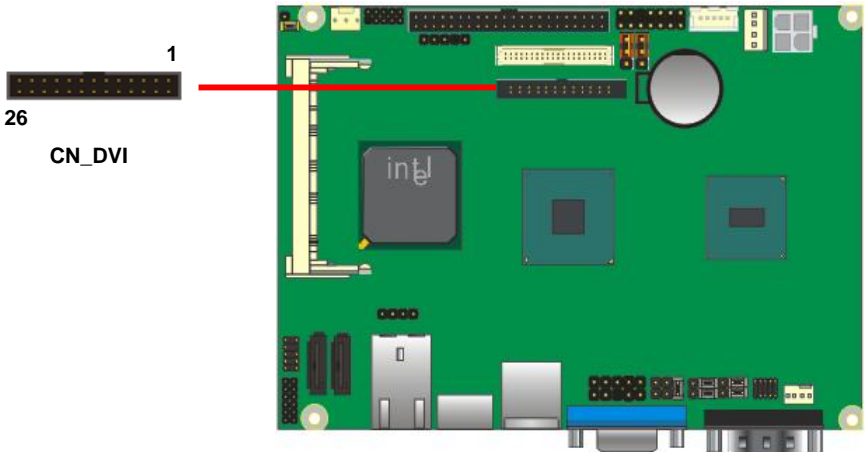

### 2.9.4 <TV-out Interface>

The board provides an HDTV interface with Intel 945GSE, supports PAL and NTSC of TV system, and display (clone or extended desktop) function with CRT, LVDS and DVI.

Connector: **CN\_HDTV**

Connector type: 10-pin header HDTV connector (pitch = 2.54mm)

Pin Number	Assignment	Pin Number	Assignment
1	GND	2	DACB1
3	DACB2	4	N/C
5	GND	6	GND
7	DACB3	8	N/C
9	N/C	10	N/C

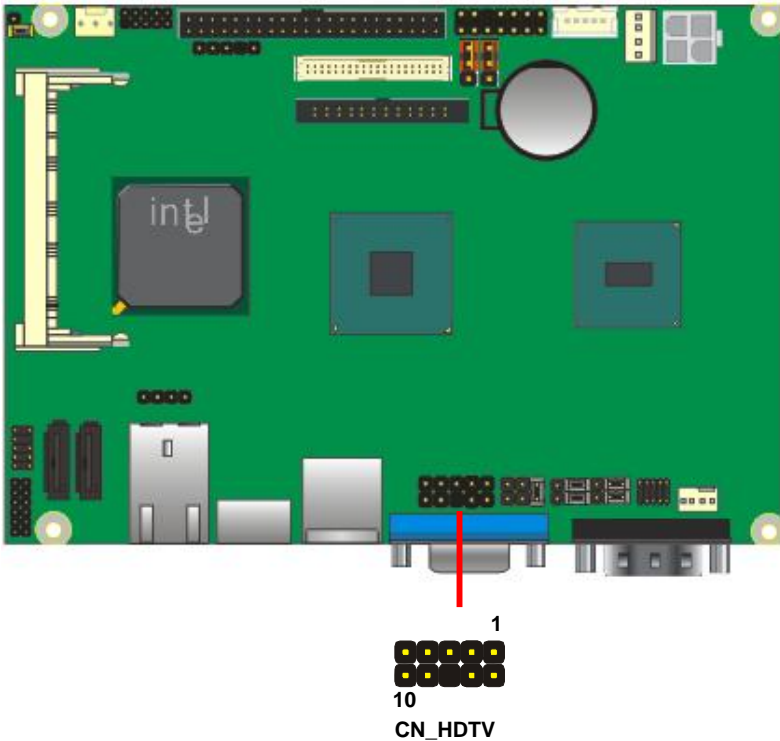

After setup the devices well, you need to select the LCD panel type in the BIOS.



The panel type mapping is list below:

LE-374 BIOS panel type selection form			
On board 18 bit LVDS			
Single channel		Dual channel	
NO.	Output format	NO.	Output format
1	640 x 480	9	1280 x 768
2	800 x 480		
3	800 x 600		
4	1024 x 600		
5	1024 x 768		
6	1280 x 600		
7	1280 x 768		
8	1280x 800		

## 2.10 <Onboard Audio Interface>

The board provides the onboard AC97 5.1-channel audio interface with Realtek ALC655

### Connector: CN\_AUDIO

Type: 10-pin (2 x 5) 2.0mm x 2.0 mm-pitch header

Pin	Description	Pin	Description
1	LIN_L	2	Ground
3	LIN_R	4	MIC 2
5	MIC 2	6	Ground
7	N/C	8	FRONTL
9	FRONTR	10	Ground

### Connector: CDIN

Type: 4-pin header (pitch = 2.54mm)

Pin	Description
1	CD – Left
2	Ground
3	Ground
4	CD – Right

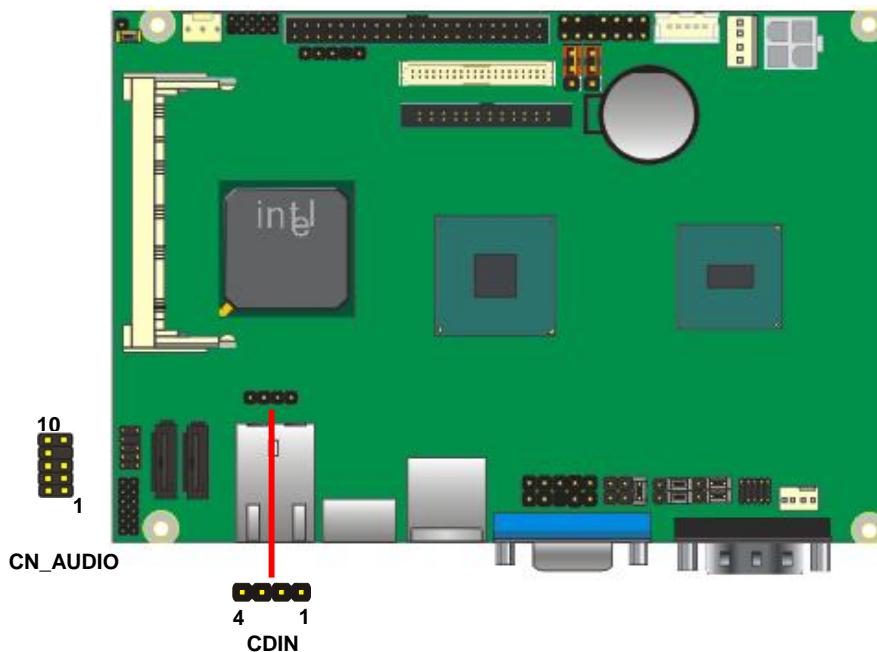

## 2.11 <USB2.0 Interface>

Based on Intel ICH7M , the board provides 4 USB2.0 ports. The USB2.0 interface provides up to 480Mbps of transferring rate.

Interface	USB2.0
Controller	ICH7M
Transfer Rate	Up to 480Mb/s
Output Current	500mA

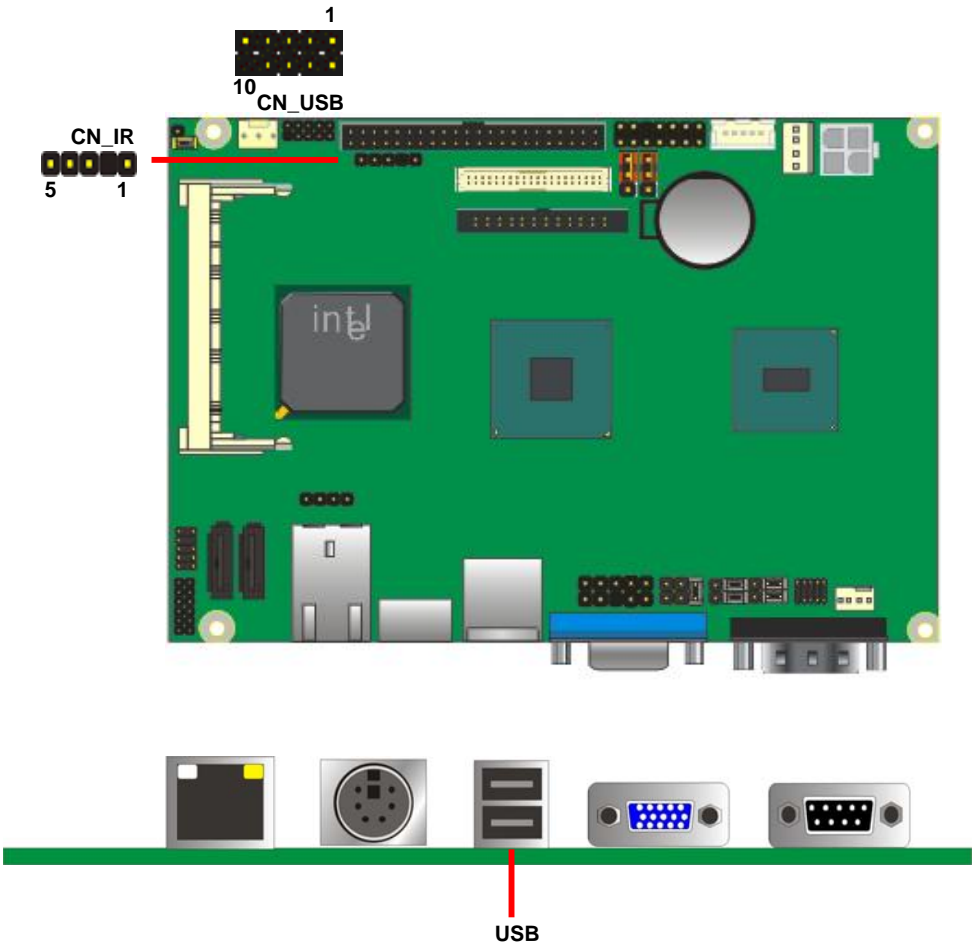

Connector: **CN\_IR**

Type: 5-pin header for SIR Port

Pin	Description
1	Vcc
2	N/C
3	IRRX
4	Ground
5	IRTX

Connector: **CN\_USB**

Type: 10-pin (5 x 2) header for USB Port

Pin	Description	Pin	Description
1	VCC	2	VCC
3	Data0-	4	Data1-
5	Data0+	6	Data1+
7	Ground	8	Ground
9	Ground	10	N/C

PS: The USB2.0 will be only active when you connecting with the USB2.0 devices, if you insert an USB1.1 device, the port will be changed to USB1.1 protocol automatically. The transferring rate of USB2.0 as 480Mbps is depends on device capacity, exact transferring rate may not be up to 480Mbps.



## 2.12 <GPIO Interface>

The board provides a programmable 8-bit digital I/O interface; you can use this general purpose I/O port for system control like POS or KIOSK.

Connector: **CN\_DIO**

Type: onboard 2 x 6-pin header, pitch=2.0mm

Pin	Description	Pin	Description
1	Ground	2	Ground
3	GP0	4	GP4
5	GP1	6	GP5
7	GP2	8	GP6
9	GP3	10	GP7
11	VCC	12	+12V

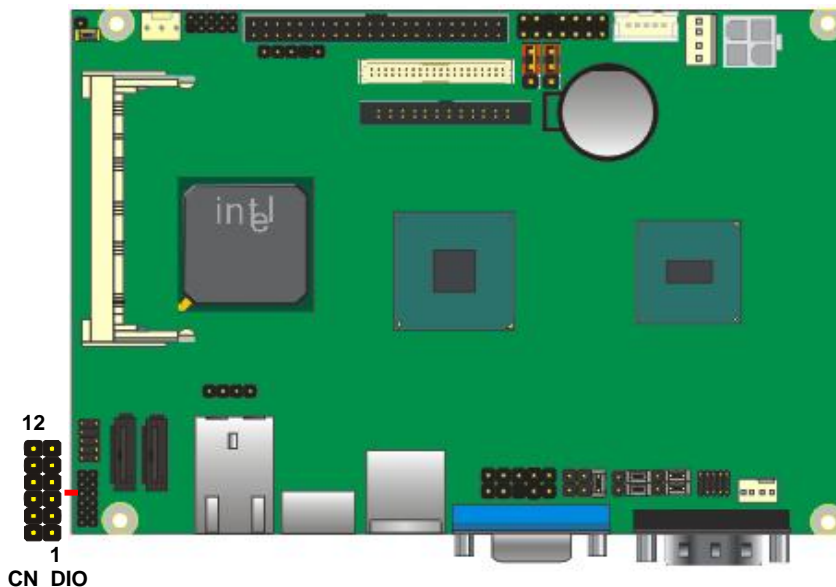

### 2.13 <Serial Port Jumper Setting >

The board provides three RS232 serial ports, with jumper selectable RS422/485 for COM2.

Connector: **CN\_COM2**

Type: 10-pin (5 x 2) 1.27mm x 2.54mm-pitch header for COM2



Pin	Description	Pin	Description
1	DCD/422TX-/485-	2	RXD/422TX+/485+
3	TXD/422RX+	4	DTR/422RX-
5	GND	6	DSR
7	RTS	8	CTS
9	RI	10	N/C

	JCSEL1	JCSEL2
RS-232		
RS-485		
RS-422		

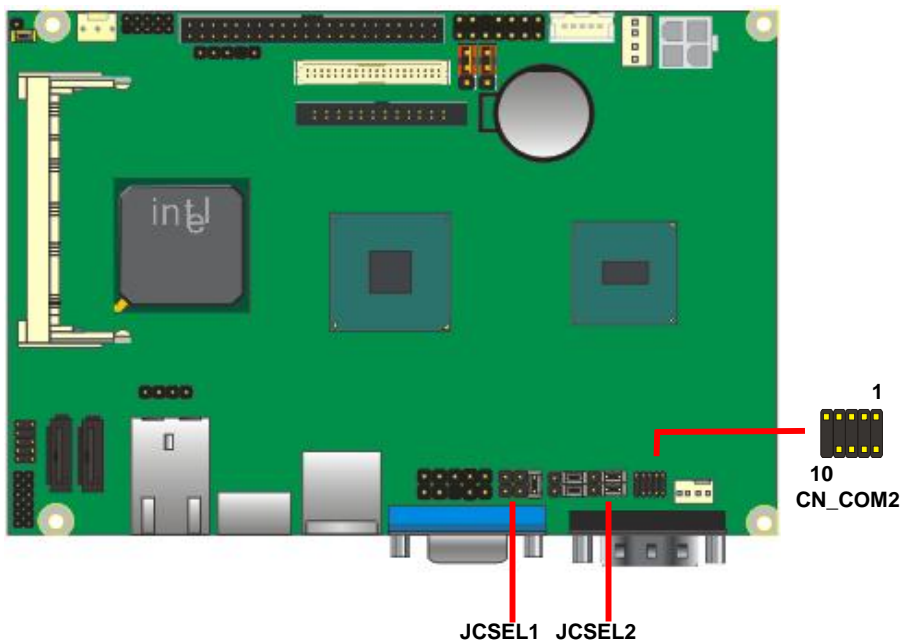

## 2.14 <Power and Fan Connector>

The board requires DC input with 4-pin header, the input voltage range is from 9V to 24V, for the input current, please take a reference of the power consumption report on appendix.

### 2.14.1 <Power Input>

Connector: DC\_IN

Type: 4-pin header

Pin	Description	Pin	Description
1	Ground	4	+12V
2	Ground	3	+12V

**Remark:** DC input voltage range 9~24V

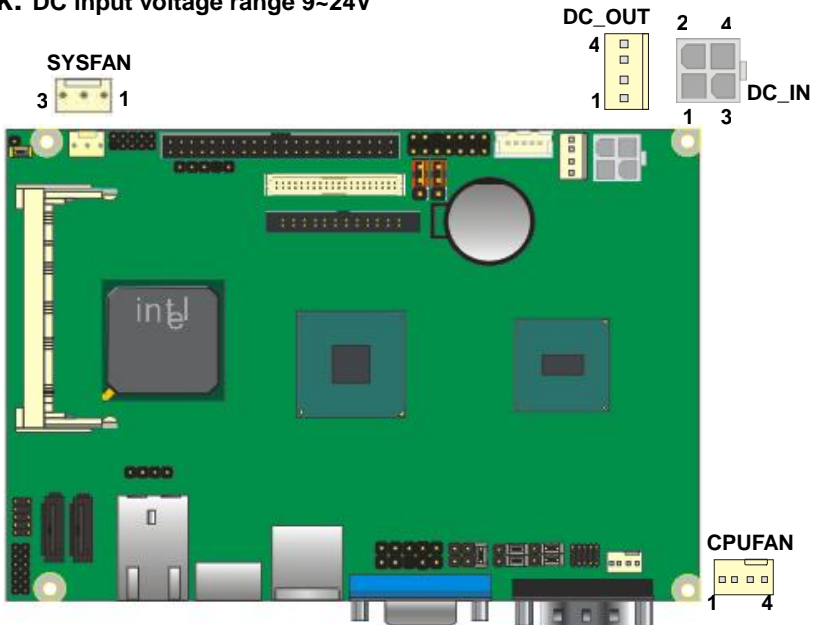

### 2.14.2 <Power Output>

Connector: **DC\_OUT**

Type: 4-pin connector for +5V/+12V **output**

Pin	Description	Pin	Description	Pin	Description	Pin	Description
1	+12V	2	Ground	3	Ground	4	+5V

**Note: Maximum output current 12V/3A, 5V/3A**

### 2.14.3 <Fan Connector>

Connector: **SYSFAN**

Type: 3-pin fan wafer connector

Pin	Description	Pin	Description	Pin	Description
1	Ground	2	+12V	3	Fan Speed detect

Connector: **CPUFAN**

Type: 4-pin P-type connector

Pin	Description	Pin	Description	Pin	Description	Pin	Description
1	+12V	2	Ground	3	Fan Speed detect	4	Fan Control

## 2.15 <Indicator and Switch>

The **JFRNT** provides front control panel of the board, such as power button, reset and beeper, etc. Please check well before you connecting the cables on the chassis.

## LE-374 User's Manual

---

Connector: **JFRNT**

Type: onboard 14-pin (2 x 7) 2.54-pitch header

Function	Signal	PIN		Signal	Function
IDE LED	HDLED+	1	2	PWRLED+	Power LED
	HDLED-	3	4	N/C	
Reset	Reset+	5	6	PWRLED-	Speaker
	Reset-	7	8	SPK+	
N/C		9	10	N/C	
Power	PWRBT+	11	12	N/C	
Button	PWRBT-	13	14	SPK-	

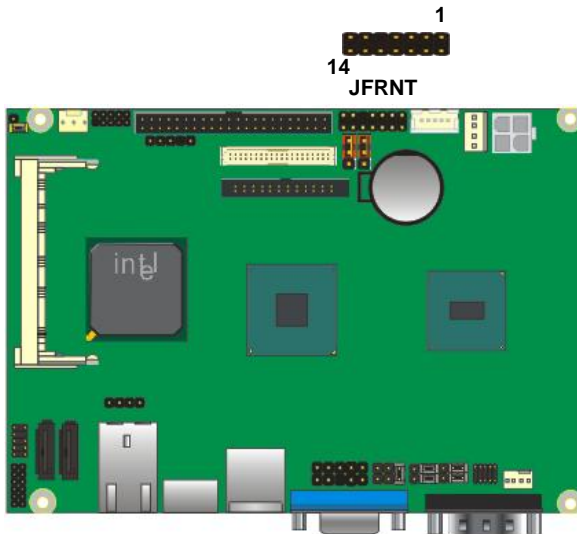

**(This Page is Left For Blank)**

## Chapter 3 <System Configuration>

### 3.1 <Video Memory Setup>

Based on Intel® 945GSE chipset with GMA (Graphic Media Accelerator) 950, the board supports Intel® DVMT (Dynamic Video Memory Technology) 3.0, which would allow the video memory to be allocated up to 224MB.

To support DVMT, you need to install the Intel GMA 950 Driver with supported OS.

#### BIOS Setup:

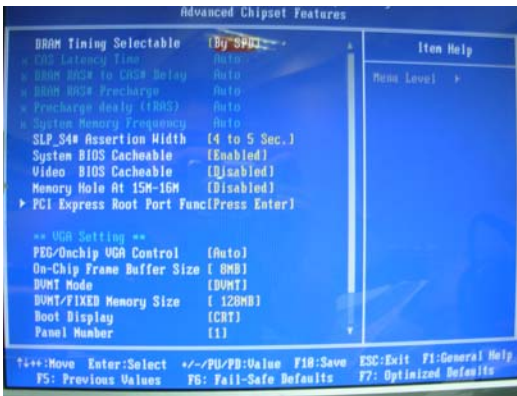

#### On-Chip Frame Buffer Size:

This item can let you select video memory which been allocated for legacy VGA and SVGA graphics support and compatibility. The available option is **1MB** and **8MB**.

#### Fixed + DVMT Memory Size:

You can select the fixed amount and the DVMT amount at the same time for a guaranteed video memory and additional dynamic video memory, please check the table below for available setting.



## LE-374 User's Manual

---

Notice:

1. The On-Chip Frame Buffer Size would be included in the Fixed Memory.

Please select the memory size according to this table.

System Memory	On-Chip Frame Buffer Size	Fixed Memory Size	DVMT Memory Size	Total Graphic Memory
128MB~255MB	1MB	32MB	0MB	32MB
	1MB	0MB	32MB	32MB
	8MB	32MB	0MB	32MB
	8MB	0	32MB	32MB
256MB~511MB	1MB	64MB	0MB	64MB
	1MB	0	64MB	64MB
	1MB	128MB	0MB	128MB
	1MB	0	128MB	128MB
	1MB	64MB	64MB	128MB
	8MB	64MB	0MB	64MB
	8MB	0	64MB	64MB
	8MB	128MB	0MB	128MB
	8MB	0	128MB	128MB
	8MB	64MB	64MB	128MB
512MB upper	1MB	64MB	0	64MB
	1MB	0	64MB	64MB
	1MB	128MB	0	128MB
	1MB	0	128MB	128MB
	1MB	64MB	64MB	128MB
	8MB	64MB	0	64MB
	8MB	0	64MB	64MB
	8MB	128MB	0	128MB
	8MB	0	128MB	128MB
	8MB	64MB	64MB	128MB

### 3.2 <Audio Configuration>

The board provides 5.1 channel audio interface with driver installed, please install the Realtek ALC655 audio driver in the CD before getting start to enjoy the 5.1 channel sound system.

1. Install REALTEK AC97 Audio driver.



2. Launch the control panel and Sound Effect Manager.
3. Select Speaker Configuration.

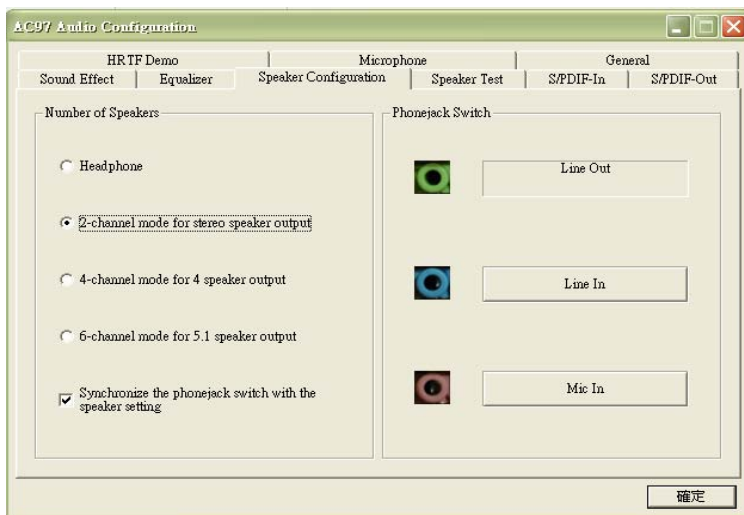

4. Select the sound mode to meet your speaker system.

**(This Page is Left for Blank)**

## Chapter 4 <BIOS Setup>

The motherboard uses the Award BIOS for the system configuration. The Award BIOS in the single board computer is a customized version of the industrial standard BIOS for IBM PC AT-compatible computers. It supports Intel x86 and compatible CPU architecture based processors and computers. The BIOS provides critical low-level support for the system central processing, memory and I/O sub-systems.

The BIOS setup program of the single board computer let the customers modify the basic configuration setting. The settings are stored in a dedicated battery-backed memory, NVRAM, retains the information when the power is turned off. If the battery runs out of the power, then the settings of BIOS will come back to the default setting.

The BIOS section of the manual is subject to change without notice and is provided here for reference purpose only. The settings and configurations of the BIOS are current at the time of print, and therefore they may not be exactly the same as that displayed on your screen.

To activate CMOS Setup program, press <DEL> key immediately after you turn on the system. The following message "Press DEL to enter SETUP" should appear in the lower left hand corner of your screen. When you enter the CMOS Setup Utility, the Main Menu will be displayed as **Figure 4-1**. You can use arrow keys to select your function, press <Enter> key to accept the selection and enter the sub-menu.

**Figure 4-1** CMOS Setup Utility Main Screen

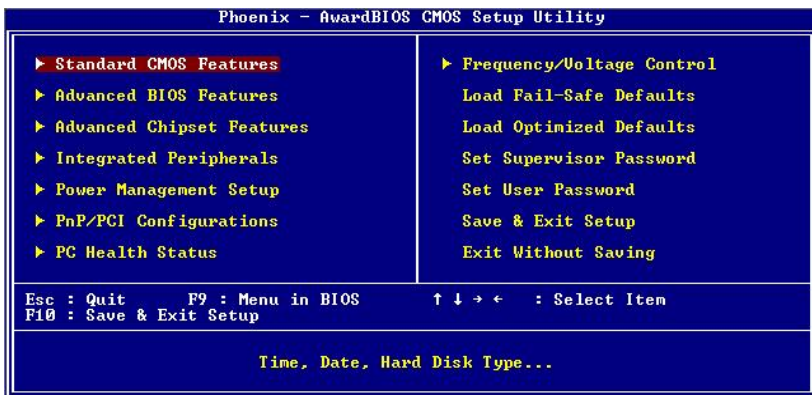

**(This Page is Left for Blank)**

## Appendix A <I/O Port Pin Assignment>

### A.1 <IDE Port>

Connector: **IDE**

Type: 44-pin (22 x 2) box header



Pin	Description	Pin	Description
1	Reset	2	Ground
3	D7	4	D8
5	D6	6	D9
7	D5	8	D10
9	D4	10	D11
11	D3	12	D12
13	D2	14	D13
15	D1	16	D14
17	D0	18	D15
19	Ground	20	N/C
21	REQ	22	Ground
23	IOW-/STOP	24	Ground
25	IOR-/HDMARDY	26	Ground
27	IORDY/DDMARDY	28	Ground
29	DACK-	30	Ground
31	IRQ	32	N/C
33	A1	34	SD
35	A0	36	A2
37	CS1	38	CS3
39	ASP1	40	Ground
41	Vcc	42	Vcc
43	Ground	44	Ground

## A.2 <IrDA Port>

Connector: **CN\_IR**

Type: 5-pin header for SIR Port



Pin	Description
1	Vcc
2	N/C
3	IRRX
4	Ground
5	IRTX

## A.3 < CRT Port >

Connector: CRT

Type: 15-pin D-sub female connector on rear panel

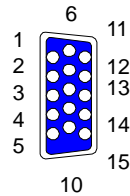

Pin	Description	Pin	Description	Pin	Description
1	RED	6	Ground	11	N/C
2	GREEN	7	Ground	12	5VCCA
3	BLUE	8	Ground	13	HSYNC
4	N/C	9	LVGA5V	14	VSYNC
5	Ground	10	Ground	15	5VCLK

## A.4 <Serial ATA Port>

Connector: **SATA1/2**

Type: 7-pin wafer connector

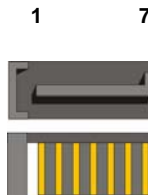

1	2	3	4	5	6	7
GND	RSATA_TXP1	RSATA_TXN1	GND	RSATA_RXN1	RSATA_RXP1	GND

## A.5 <Serial Port>

Connector: **COM1**

Type: 9-pin D-sub male connector on rear panel

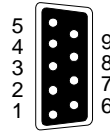

Pin	Description	Pin	Description
1	DCD	6	DSR
2	SIN	7	RTS
3	SO	8	CTS
4	DTR	9	RI
5	Ground		

## A.6 <LAN Port>

Connector: **RJ45**

Type: RJ45 connector with LED on rear panel

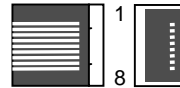

Pin	1	2	3	4	5	6	7	8
Description	TRD0+	TRD0-	TRD1+	TRD2+	TRD2-	TRD1-	TRD3+	TRD3-



## **Appendix B <Flash BIOS>**

### **B.1 BIOS Auto Flash Tool**

The board is based on Award BIOS and can be updated easily by the BIOS auto flash tool. You can download the tool online at the address below:

<http://www.award.com>

<http://www.commell.com.tw/support/support.htm>

File name of the tool is "awdf flash.exe", it's the utility that can write the data into the BIOS flash ship and update the BIOS.

### **B.2 Flash Method**

1. Please make a bootable floppy disk.
2. Get the last .bin files you want to update and copy it into the disk.
3. Copy awardflash.exe to the disk.
4. Power on the system and flash the BIOS. (Example: C:/ awardflash XXX.bin)
5. Re-star the system.

Any question about the BIOS re-flash please contact your distributors or visit the web-site at below:

<http://www.commell.com.tw/support/support.htm>

## Appendix C <System Resources>

### C1.<I/O Port Address Map>

[00000000 - 0000000F]	Direct memory access controller
[00000010 - 0000001F]	PCI bus
[00000020 - 00000021]	Programmable interrupt controller
[00000022 - 0000003F]	PCI bus
[00000040 - 00000043]	System timer
[00000044 - 00000047]	PCI bus
[0000004C - 0000006F]	PCI bus
[00000060 - 00000060]	PC/AT PS/2 Keyboard (84-Key)
[00000061 - 00000061]	System speaker
[00000064 - 00000064]	PC/AT PS/2 Keyboard (84-Key)
[00000070 - 00000071]	System CMOS/real time clock
[00000072 - 0000007F]	PCI bus
[00000081 - 00000083]	Direct memory access controller
[00000087 - 00000087]	Direct memory access controller
[00000089 - 0000008B]	Direct memory access controller
[0000008F - 00000091]	Direct memory access controller
[00000090 - 00000091]	PCI bus
[00000093 - 0000009F]	PCI bus
[000000A0 - 000000A1]	Programmable interrupt controller
[000000A2 - 000000BF]	PCI bus
[000000C0 - 000000DF]	Direct memory access controller
[000000D0 - 000000EF]	PCI bus
[000000F0 - 000000FF]	Numeric data processor
[00000100 - 00000CF7]	PCI bus
[00000170 - 00000177]	Secondary IDE Channel
[000001F0 - 000001F7]	Primary IDE Channel
[00000200 - 00000200]	Standard Game Port
[00000201 - 00000207]	Standard Game Port
[00000274 - 00000277]	ISAPNP Read Data Port
[00000279 - 00000279]	ISAPNP Read Data Port
[000002F8 - 000002FF]	Communications Port (COM2)
[00000376 - 00000376]	Secondary IDE Channel
[00000378 - 0000037F]	Printer Port (LPT1)
[000003B0 - 000003BB]	Mobile Intel(R) 945 Express Chipset Family
[000003C0 - 000003DF]	Mobile Intel(R) 945 Express Chipset Family

[000003F0 - 000003F5]	Standard floppy disk controller
[000003F6 - 000003F6]	Primary IDE Channel
[000003F7 - 000003F7]	Standard floppy disk controller
[000003F8 - 000003FF]	Communications Port (COM1)
[000004F8 - 000004FF]	Communications Port (COM4)
[000004F8 - 000004FF]	Communications Port (COM5)
[00000500 - 0000051F]	Intel(R) 82801G (ICH7 Family) SMBus Controller - 27DA
[00000778 - 0000077B]	Printer Port (LPT1)
[00000A79 - 00000A79]	ISAPNP Read Data Port
[00000D00 - 0000FFFF]	PCI bus
[0000C000 - 0000CFFF]	Intel(R) 82801G (ICH7 Family) PCI Express Root Port - 27D0
[0000CF00 - 0000CF1F]	Intel(R) 82574L Gigabit Network Connection
[0000F000 - 0000F0FF]	Realtek AC'97 Audio
[0000F800 - 0000F80F]	Intel(R) 82801GBM/GHM (ICH7-M Family) Serial ATA Storage Controller - 27C4
[0000FA00 - 0000FA3F]	Realtek AC'97 Audio
[0000FB00 - 0000FB1F]	Intel(R) 82801G (ICH7 Family) USB Universal Host Controller - 27CB
[0000FC00 - 0000FC1F]	Intel(R) 82801G (ICH7 Family) USB Universal Host Controller - 27CA
[0000FD00 - 0000FD1F]	Intel(R) 82801G (ICH7 Family) USB Universal Host Controller - 27C9
[0000FE00 - 0000FE1F]	Intel(R) 82801G (ICH7 Family) USB Universal Host Controller - 27C8
[0000FF00 - 0000FF07]	Mobile Intel(R) 945 Express Chipset Family

**C2. <Memory Address Map>**

[00000000 - 0009FFFF]	System board
[0009F000 - 000BFFFF]	PCI bus
[000A0000 - 000BFFFF]	Mobile Intel(R) 945 Express Chipset Family
[000CEC00 - 000CFFFF]	PCI bus
[000D1000 - 000D3FFF]	Motherboard resources
[000D1000 - 000DFFFF]	PCI bus
[000F0000 - 000F3FFF]	Motherboard resources
[000F4000 - 000F7FFF]	Motherboard resources
[000F8000 - 000FFFFF]	Motherboard resources
[00100000 - 00FFFFFF]	System board
[7F700000 - DFFFFFFF]	PCI bus
[D0000000 - DFFFFFFF]	Mobile Intel(R) 945 Express Chipset Family
[F0000000 - FEBFFFFF]	PCI bus
[FDB00000 - FDBFFFFF]	Intel(R) 82801G (ICH7 Family) PCI Express Root Port - 27D0
[FDBC0000 - FDBDFFFF]	Intel(R) 82574L Gigabit Network Connection
[FDBFC000 - FDBFFFFF]	Intel(R) 82574L Gigabit Network Connection
[FDC00000 - FDCFFFFF]	Intel(R) 82801G (ICH7 Family) PCI Express Root Port - 27D0
[FDF00000 - FDF7FFFF]	Mobile Intel(R) 945 Express Chipset Family
[FDF80000 - FDFBFFFF]	Mobile Intel(R) 945 Express Chipset Family
[FDFFD000 - FDFFD0FF]	Realtek AC'97 Audio
[FDFFE000 - FDFFE1FF]	Realtek AC'97 Audio
[FDFFF000 - FDFFF3FF]	Intel(R) 82801G (ICH7 Family) USB2 Enhanced Host Controller - 27CC
[FEB80000 - FEBFFFFF]	Mobile Intel(R) 945 Express Chipset Family
[FEC00000 - FEC0FFFF]	System board
[FEE00000 - FEE0FFFF]	System board
[FFB00000 - FFB7FFFF]	System board
[FFB80000 - FFBFFFFF]	Intel(R) 82802 Firmware Hub Device
[FFF00000 - FFFFFFFF]	System board

### **C3. <System IRQ Resources>**

- (ISA) 0 System timer
- (ISA) 1 PC/AT PS/2 Keyboard (84-Key)
- (ISA) 3 Communications Port (COM2)
- (ISA) 4 Communications Port (COM1)
- (ISA) 6 Standard floppy disk controller
- (ISA) 8 System CMOS/real time clock
- (ISA) 12 Microsoft PS/2 Mouse
- (ISA) 13 Numeric data processor
- (ISA) 14 Primary IDE Channel
- (ISA) 15 Secondary IDE Channel
- (PCI) 8 Mobile Intel(R) 945 Express Chipset Family
- (PCI) 112 Intel(R) 82801G (ICH7 Family) PCI Express Root Port - 27D0
- (PCI) 116 Intel(R) 82801G (ICH7 Family) USB Universal Host Controller - 27C8
- (PCI) 116 Intel(R) 82801G (ICH7 Family) USB2 Enhanced Host Controller - 27CC
- (PCI) 117 Intel(R) 82801G (ICH7 Family) USB Universal Host Controller - 27C9
- (PCI) 118 Intel(R) 82801G (ICH7 Family) USB Universal Host Controller - 27CA
- (PCI) 119 Intel(R) 82801G (ICH7 Family) USB Universal Host Controller - 27CB
- (PCI) 120 Realtek AC'97 Audio
- (PCI) 125 Intel(R) 82801G (ICH7 Family) SMBus Controller - 27DA
- (PCI) 128 Intel(R) 82574L Gigabit Network Connection

## Appendix D <Programming GPIO's>

The GPIO can be programmed with the MSDOS debug program using simple IN/OUT commands. The following lines show an example how to do this.

GPIO0.....GPIO7 bit0.....bit7

```
-o 2E 87                ;enter configuration
-o 2E 87
-o 2E 29
-o 2F 40                ;enable GPIO function
-o 2E 07
-o 2F 07                Select Logic Device 7
-o 2E F0
-o 2F xx                ;set GPIO as input/output; set '1' for input,'0' for
output
-o 2E F1
-o 2F xx                ;if set GPIO's as output,in this register its value can
be set
```

Optional :

```
-o 2E F2
-o 2F xx                ; Data inversion register ; '1' inverts the current valus
of the bits ,'0' leaves them as they are
-o 2E 30
-o 2F 01                ; active GPIO's
```

For further information, please refer to Winbond W83627THF datasheet.

## Appendix E <Watch Dog timer Setting >

The watchdog timer makes the system auto-reset while it stops to work for a period. The integrated watchdog timer can be setup as system reset mode by program.

### Timeout Value Range

- 1 to 255
- Second or Minute

### Program Sample

Watchdog timer setup as system reset with 5 second of timeout

```
2E, 87
2E, 87
2E, 07
2F, 08      Logical Device 8
2E, 30      Activate
2F, 01
2E, F5      Set as Second*
2F, 00
2E, F6      Set as 5
2F, 05
```

\* Minute: bit 3 = 0; Second: bit 3 = 1

You can select Timer setting in the BIOS, after setting the time options, the system will reset according to the period of your selection.

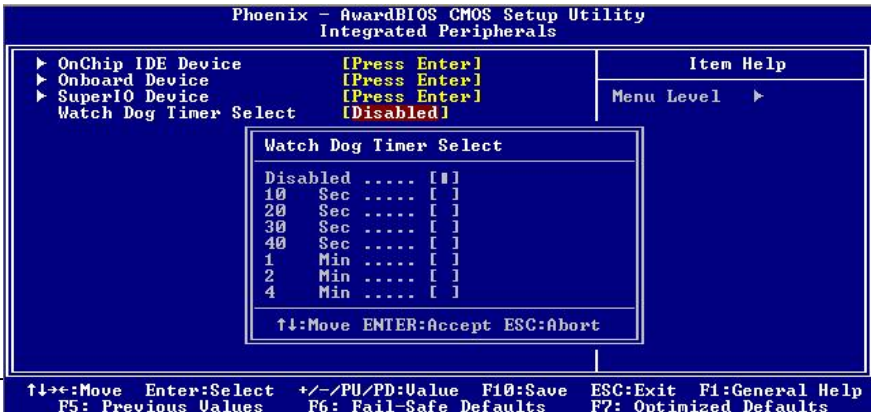

**(This Page is Left for Blank)**



## Contact Information

Any advice or comment about our products and service, or anything we can help you please don't hesitate to contact with us. We will do our best to support you for your products, projects and business.

### Taiwan Commate Computer Inc.

---

Address	8F,19F No. 94, Sec. 1, Shin Tai Wu Rd., Shi Chih Taipei Hsien, Taiwan
TEL	+886-2-26963909
FAX	+886-2-26963911
Website	<a href="http://www.commell.com.tw">http://www.commell.com.tw</a>
E-Mail	<a href="mailto:info@commell.com.tw">info@commell.com.tw</a> (General Information) <a href="mailto:tech@commell.com.tw">tech@commell.com.tw</a> (Technical Support)

---

**Commell is our trademark of industrial PC division**