

FE-97G

Full-size PICMG CPU Card

User's Manual

Edition 1.0

2010/05/27



Copyright

Copyright 2010, all rights reserved. This document is copyrighted and all rights are reserved. The information in this document is subject to change without prior notice to make improvements to the products.

This document contains proprietary information and protected by copyright. No part of this document may be reproduced, copied, or translated in any form or any means without prior written permission of the manufacturer.

All trademarks and/or registered trademarks contains in this document are property of their respective owners.

Disclaimer

The company shall not be liable for any incidental or consequential damages resulting from the performance or use of this product.

The company does not issue a warranty of any kind, express or implied, including without limitation implied warranties of merchantability or fitness for a particular purpose.

The company has the right to revise the manual or include changes in the specifications of the product described within it at any time without notice and without obligation to notify any person of such revision or changes.

Trademark

All trademarks are the property of their respective holders.

Any questions please visit our website at <http://www.commell.com.tw>

Packing List:

Please check the package content before you starting using the board.

Hardware:

FE-97G Full-size PICMG CPU Card x 1

Cable Kit:



Audio Port Cable x 1



PS/2 Keyboard & Mouse Cable x 1



SATA Cable x 2



DVI module with DVI Cable x 1
(FE-97GTXDG & FE-97GTXDG2)

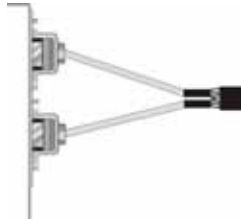

USB Cable x 2



FDD cable x 1



ATX cable x 1



40-pin ATA100 IDE cable x 1

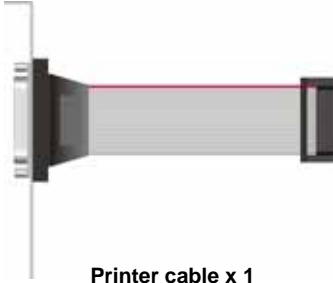

Printer cable x 1
(FE-97GTXG2 & FE-97GTXDG2)



Com Cable x 1
(FE-97GTXG2 & FE-97GTXDG2)

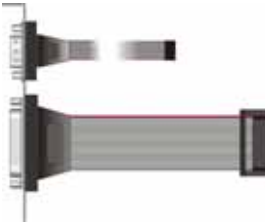

COM & Printer cable x 1
(FE-97GTXG & FE-97GTXDG)

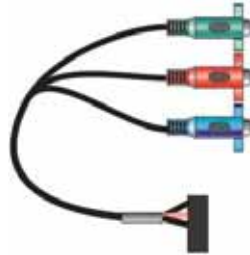

HDTV Port Cable x 1 (Optional)

Printed Matters:

Driver CD x 1 (including User's Manual)

Index

Chapter 1 <Introduction>	7
1.1 <Product Overview>.....	7
1.2 <Product Specification>	9
1.3 <Mechanical Drawing>	11
1.4 <Block Diagram>	12
Chapter 2 <Hardware Setup>	13
2.1 <Connector Location>	13
2.2 <Connector Reference>	14
2.2.1 <Internal Connectors>.....	14
2.2.2 <External Connectors>.....	14
2.3 <Jumper Location & Reference>.....	15
2.4 <Memory Setup >	16
2.5 <CMOS Setup>	17
2.6 <Enhanced IDE & CF Interface>	18
2.7 <Serial ATA Interface>	19
2.8 <Ethernet Interface>	20
2.9 <Onboard Display Interface>	21
2.9.1 <Analog VGA Interface>.....	21
2.9.2 <Digital Display>.....	22
2.9.3 <HDTV Interface>	26
2.9.4 <DVI Interface >.....	27
2.10 <Integrated Audio Interface>.....	28
2.11 <GPIO Interface>	30
2.12 <Power and Fan Installation>.....	31
2.12.1 <Power connectors>.....	31
2.12.2 <Fan Connectors>	31
2.12.3 <ATX Power Mode>.....	33
2.13 <Switch and Indicator>.....	34

Chapter 3 <System Setup>	35
3.1 <Audio Configuration>	35
3.2 <Video Memory Setup>	36
3.3 <Display Properties Setting>	37
Chapter 4 <BIOS Setup>	39
Appendix A <I/O Port Pin Assignment>	41
A.1 <Serial ATA Port>	41
A.2 <IrDA Port>	41
A.3 <SMBUS Port>	42
A.4 <Serial Port 2>	42
A.5 < RS-232, RS-422, RS-485 & IrDA >	43
A.6 <Parallel Port>	44
A.7 <LAN Port>	44
A.8 <USB Interface>	44
A.9 <DVI Port>	45
A.10 <PS/2 Keyboard & Mouse Port>	45
Appendix B <Flash BIOS>	46
B.1 <Flash Tool>	46
B.2 <Flash BIOS Procedure>	46
Appendix C <System Resources>	47
C.1 <Direct Memory Access (DMA)>	47
C.2 <Direct Memory Access (IRQ)>	47
C.3 <Input /Output (IO)>	48
C.4 <Memory Address Map>	50
Appendix D <Programming GPIO's>	51
Appendix E <Programming Watchdog Timer>	52
Contact Information	53

(This page is left for blank)

Chapter 1 <Introduction>

1.1 <Product Overview>

FE-97G is the Full-size PICMG 1.0 CPU Card, with Intel® Atom N270 processor for 533 MHz front side bus, Intel® 945GSE and ICH7M chipset, integrated GMA950 graphics, DDR2 SO-DIMM memory, Realtek AC97 Audio, Serial ATA and two Intel® 82574L Gigabit LAN.

Intel Atom Processor

The Intel® Atom N270 single core processor is with 533 MHz front side bus, 512KB L2 cache. It's built on 45nm process technology support Hyper-Threading Technology, Enhanced Intel SpeedStep® Technology reduces average system power consumption.

Mobile Intel® 945GSE chipset

The board integrates Intel® 945GSE and ICH7M chipset. The chipset features power-efficient graphics with an integrated 32-bit 3D graphics engine based on Intel® Graphics Media Accelerator 950 architecture with LVDS, CRT, and TV-Out display ports. It provides I/O capabilities and flexibility via high-bandwidth interfaces such as PCI, Serial ATA and Hi-Speed USB 2.0 connectivity. It also includes a single channel for 400/533 MHz DDR2 system memory (SODIMM), HD Audio with 7.1 channels surrounding sound.

All in One multimedia solution

Based on Intel 945GSE and ICH8M chipset, the board provides high performance onboard graphics, 18-bit Dual channel LVDS interface, HDTV and 2 channels ac97 Audio, to meet the every requirement of the multimedia application

Flexible Extension Interface

The board provides two PCI Express mini card, one mini-PCI socket and one CF socket.

1.2 <Product Specification>

General Specification

Form Factor	Full-size PICMG CPU Card PICMG version 1.0 (Rev. 2.0), PCI version 2.0 compliant
CPU	Intel® Atom N270 processor Package type: FCBGA8 Front side bus: 533MHz
Memory	1 x 200-pin DDR2 SO-DIMM SDRAM up to 2GB Unbuffered, none-ECC memory supported only
Chipset	Intel® 945GSE and ICH7M
BIOS	Phoenix-Award v6.00PG 8Mb SPI flash BIOS
Green Function	Power saving mode includes doze, standby and suspend modes. ACPI version 2.0 and APM version 1.2 compliant
Watchdog Timer	System reset programmable watchdog timer with 1 ~ 255 sec./min. of timeout value
Real Time Clock	Chipset integrated RTC with onboard lithium battery
IDE	UltraATA133 IDE interface supports up to 2 ATAPI devices One 44-pin IDE port onboard One CompactFlash Type II socket
Serial ATA	Intel® ICH7M integrates 2 Serial ATA interfaces (No RAID Function) Up to 150MB/s of transfer rate

Multi-I/O Port

Chipset	Intel® ICH7M with Winbond® W83627DHG-P controller
Serial Port	Five RS232 and one jumper selectable RS232/422/485
Parallel Port	One internal bi-direction parallel port with SPP/ECP/EPP mode
Floppy Port	One internal Floppy port
USB Port	6 x Hi-Speed USB 2.0 ports with 480Mbps of transfer rate
IrDA Port	One IrDA compliant Infrared interface supports SIR
K/B & Mouse	PS/2 keyboard and mouse port on bracket
GPIO	One 12-pin Digital I/O connector with 8-bit programmable

VGA Display Interface

Chipset	Intel® 945GSE GMCH (Graphic Memory Controller Hub)
Memory	Up to 224MB shared with system memory
Display Type	CRT, LCD monitor with analog display, DVI, HDTV
Connector	External DB15 female connector Onboard 40-Pin LVDS connector (FE-97GTXDG/TXDG2) Onboard 26-Pin DVI connector (FE-97GTXDG/TXDG2) Onboard 9-Pin TV-out connector

Ethernet Interface

Chipset	Intel 82574L Gigabit Ethernet controller
Type	Triple speed 10/100/1000Base-T auto-switching Fast Ethernet Full duplex, IEEE802.3U compliant
Connector	External two RJ45 connector with LED on rear I/O panel

Audio Interface

Chipset	Intel® ICH7M with Realtek ALC655 AC97 Audio
Interface	2 channels sound output
Connector	Internal 10-pin header for line-in/-out, MIC-in, 4-pin for CD-IN

Solid State Disk Interface

Flash Type	Compact Flash Typell for Compact Flash Card
------------	---

ISA Interface

ISA Bridge	Winbond W83628AG & W83629AG
Function	I/O & IRQ supported only, no support DMA & bus mastering

Expansive Interface

Mini PCI	One Mini-PCI socket TYPE III A (32-bit, 33MHz) Power supply: +3.3V, +5V, 3VSB
PCI express mini card	Two PCIE mini card socket Power supply: +1.5V, 3VSB

Power and Environment

Power Requirement	+5V, +12 DC input & 5V _{SB} Requirement
Dimension	338 (L) x 122 (W) mm
Temperature	Operating within 0 ~ 60 °C (32 ~ 140°F) Storage within -20 ~ 85 °C (-4 ~ 185°F)

Ordering Code

FE-97GTXG	Onboard VGA, LVDS, HDTV, IDE, CF, SATA, COM, USB2.0, Mini PCI, HD Audio, 2 x PCI Express mini card, 1 x Gigabit LAN.
FE-97GTXG2	Onboard VGA, LVDS, HDTV, IDE, CF, SATA, COM, USB2.0, Mini PCI, HD Audio, 2 x PCI Express mini card, 2 x Gigabit LAN.
FE-97GTXDG	Onboard VGA, LVDS, HDTV, IDE, CF, SATA, COM, USB2.0, Mini PCI, HD Audio, DVI, 1 x PCI Express mini card, 1 x Gigabit LAN.
FE-97GTXDG2	Onboard VGA, LVDS, HDTV, IDE, CF, SATA, COM, USB2.0, Mini PCI, HD Audio, DVI, 1 x PCI Express mini card, 2 x Gigabit LAN.

1.3 <Mechanical Drawing>

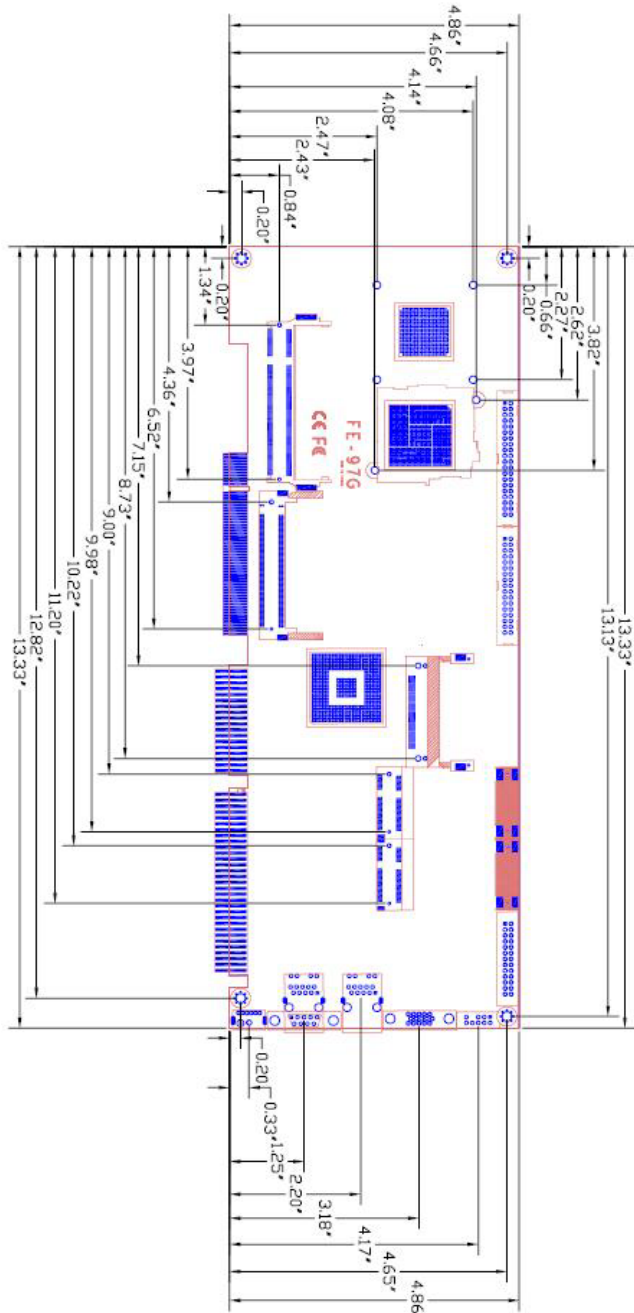

unit : inch

1.4 <Block Diagram>

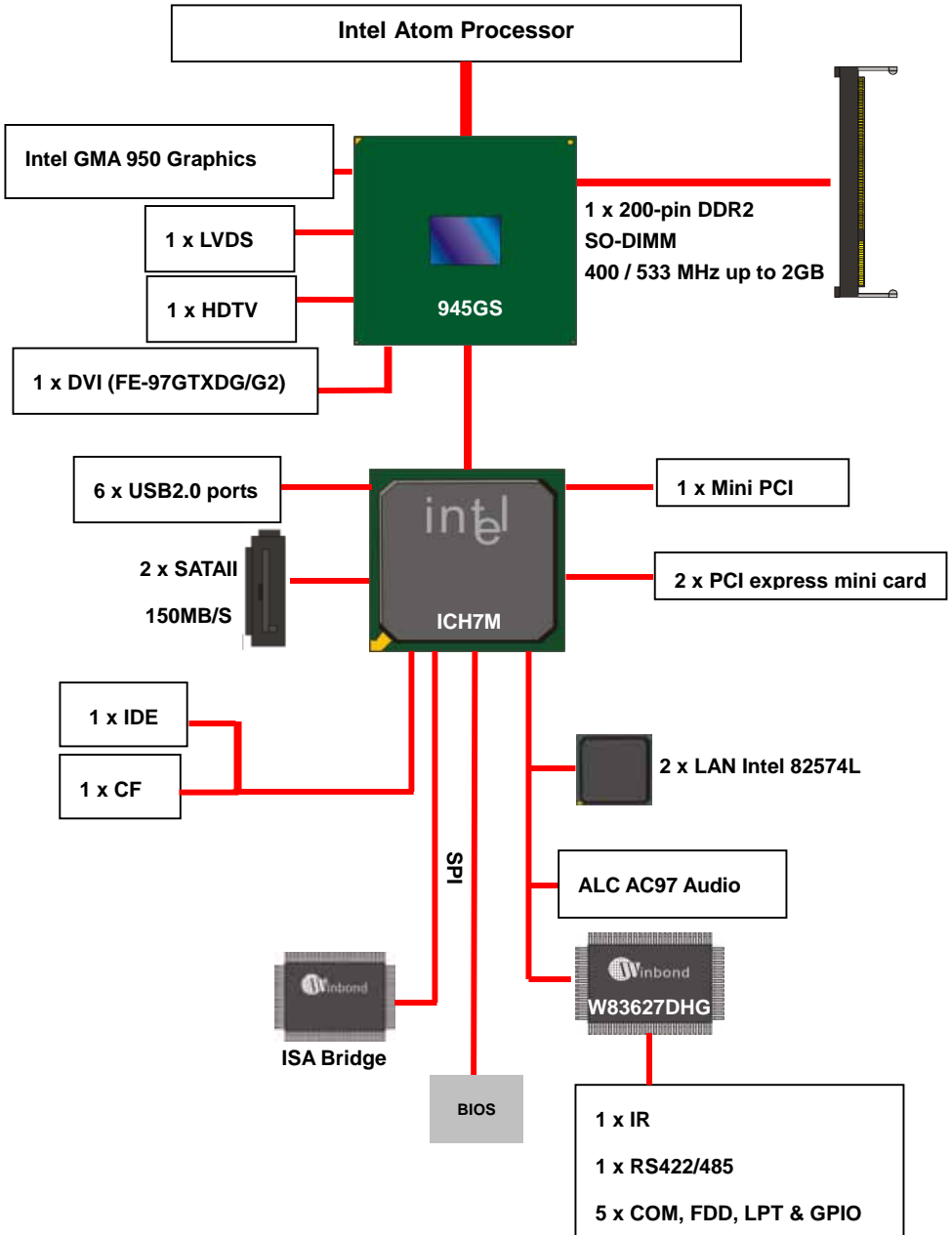

Chapter 2 <Hardware Setup>

2.1 <Connector Location>

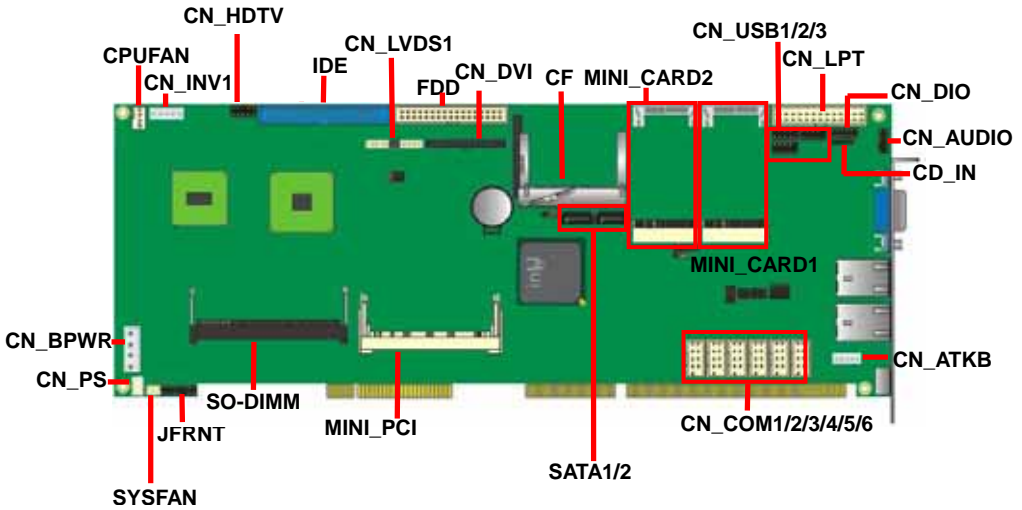

FE-97GTGX2 & FE-97GTXDG2

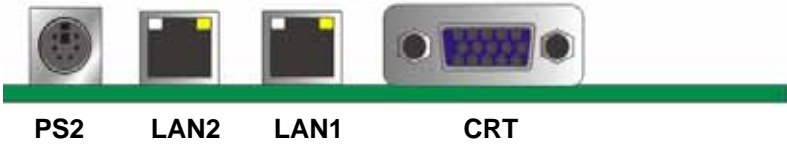

FE-97GTGX & FE-97GTXDG



2.2 <Connector Reference>

2.2.1 <Internal Connectors>

Connector	Function	Remark
SO-DIMM1/2	200-pin DDR2 SO-DIMM socket	
IDE	40-pin primary IDE connector	
CN_LPT	26-pin LPT port connector	
FDD	34-pin floppy connector	
SATA1/2	7-pin Serial ATA connector	
DC_IN	4-pin AT power supply connector	
CN_PS	3-pin power input connector	
CN_AUDIO	5 x 2-pin audio connector	
CD_IN	4-pin CD-ROM audio input connector	
CN_DIO	6 x 2-pin digital I/O connector	
CN_USB	5 x 2-pin USB connector	
CPUFAN	4-pin CPU cooler fan connector	
SYSFAN	3-pin system cooler fan connector	
CN_DVI	13 x 2-pin DVI interface	(FE-97GTXDG/G2)
CN_HDTV	5 x 2-pin HDTV interface	
CN_LVDS	20 x 2-pin LVDS connector	
CN_INV	5-pin LCD inverter connector	
CN_IR	5-pin IrDA connector	
CN_ATKB	5-pin AT keyboard connector	
JFRNT	14-pin front panel switch/indicator connector	
MiniPCI	124-pin Mini-PCI socket Type IIIA	
PCI express mini card	52-pin PCI express mini card socket	
COM 1/2/3/4/5/6	Serial port 1/2 connector	(FE-97GTXG2/XDG2)
COM 2/3/4/5/6	Serial port 2 connector	(FE-97GTXG/XDG)

2.2.2 <External Connectors>

Connector	Function	Remark
CRT	DB15 VGA connector	
PS2	PS2 keyboard & mouse	
RJ45_1/2	RJ45 LAN 1/2 connector	(FE-97GTXG2/XDG2)
RJ45_1	RJ45 LAN 1 connector	(FE-97GTXG/XDG)
COM 1	Serial port 1 connector	(FE-97GTXG/XDG)

2.3 <Jumper Location & Reference>

Jumper	Function
JRTC	CMOS Operating/Clear Setting
JVLCD	Panel Voltage Setting
JAT	Power mode select

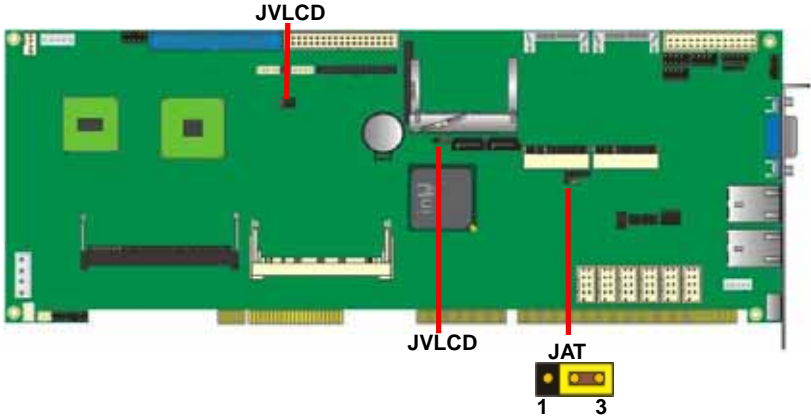

Jumper: **JAT**

Type: onboard 3-pin header

JAT	Mode
1-2	AT Mode
2-3	ATX Mode

Default setting: 2-3

2.4 < Memory Setup >

The board provides two 200-pin DDR2 SO-DIMM to support 533 MHz memory module up to 2GB. Non-ECC, unbuffered memory is supported only,

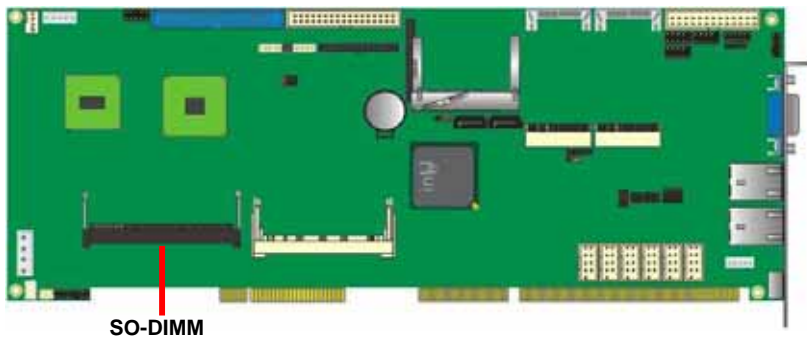

2.5 <CMOS Setup>

The board's data of CMOS can be setting in BIOS. If the board refuses to boot due to inappropriate CMOS settings, here is how to proceed to clear (reset) the CMOS to its default values.

Jumper: JRTC

Type: Onboard 3-pin jump

JRTC	Mode
1-2	Clear CMOS
2-3	Normal Operation

Default setting: 2-3

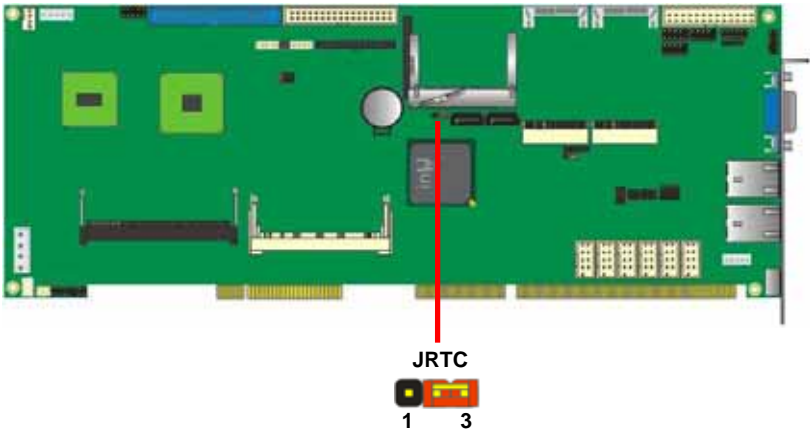

2.6 <Enhanced IDE & CF Interface>

The board has one Ultra DMA33 IDE interface to support up to 2 ATAPI devices, and one Compact Flash Type II socket on the solder side

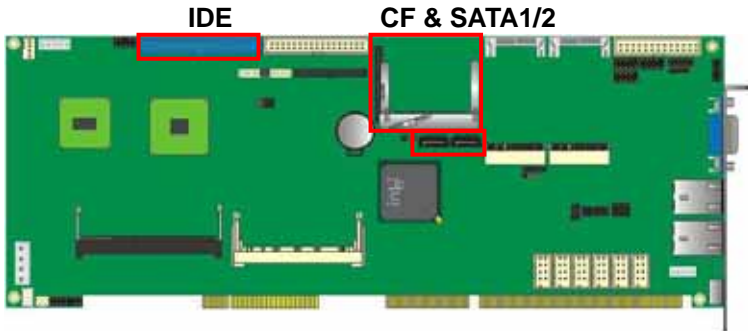

2.7 <Serial ATA Interface>

Based on Intel ICH7M, the board provides three Serial ATAII interfaces with up to 150MB/s of transfer rate and support AHCI.

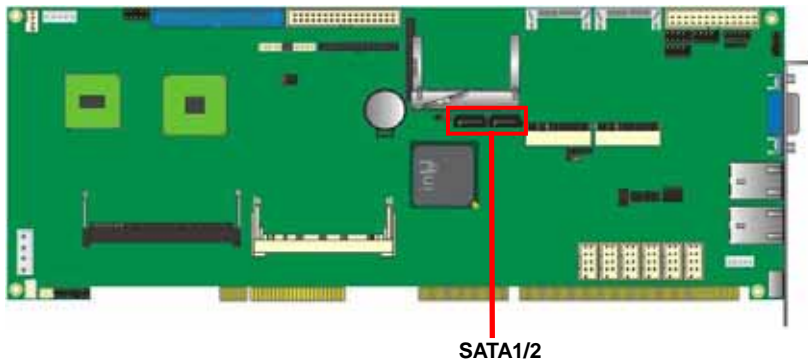

2.8 <Ethernet Interface>

The board integrates with two Intel 82574L Gigabit Ethernet controllers. The Intel Gigabit Ethernet supports triple speed of 10/100/1000Base-T, with IEEE802.3 compliance and Wake-On-LAN supported.

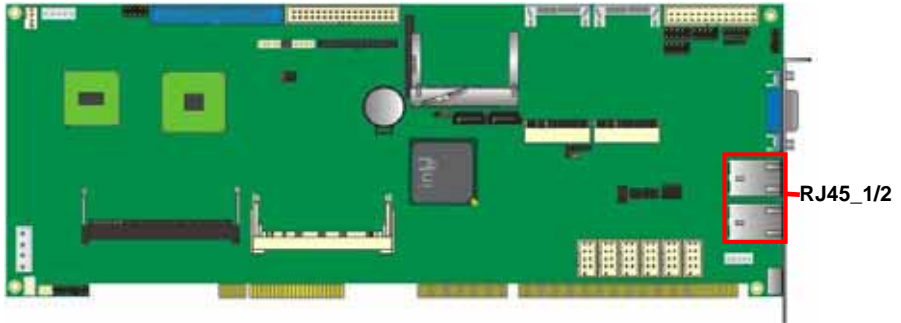

2.9 <Onboard Display Interface>

Based on Intel 945GSE chipset with built-in GMA (Graphic Media Accelerator) 950 graphics, the board provides one DB15 connector on rear external I/O port, and one 40-pin LVDS interface with 5-pin LCD backlight inverter connector. The board provides dual display function with clone mode and extended desktop mode for CRT, LCD, HDTV.

2.9.1 <Analog VGA Interface>

Please connect your CRT or LCD monitor with DB15 male connector to the onboard DB15 female connector on rear I/O port.



2.9.2 <Digital Display>

The board provides one 40-pin LVDS connector up to two mode for 18-bit single/dual channel panels, supports up to 1600 x 1200 (UXGA) resolution, with LCD backlight inverter connector and jumper for panel voltage setting.

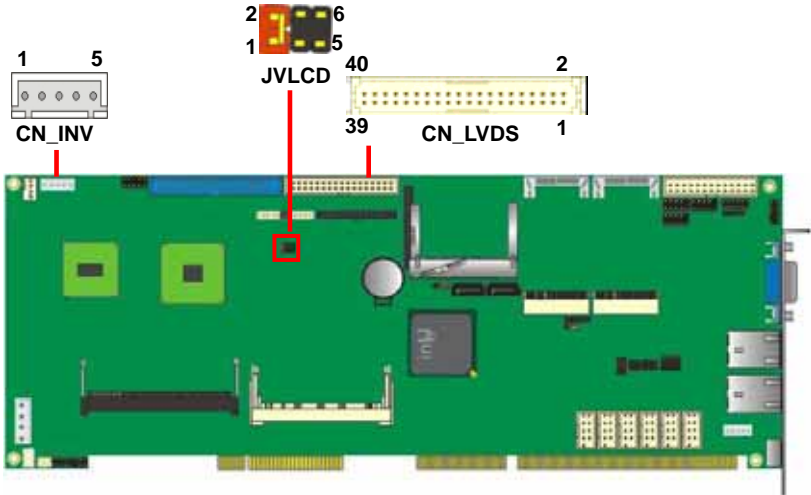

Effective patterns of connection: 1-2 / 3-4 / 5-6



Warning: others cause damages

Connector: **CN_INV**

Type: 5-pin LVDS Power Header

Pin	Description
1	+12V
2	CTLBKL
3	GND
4	GND
5	ENABKL

Connector model: **JST B5B-XH-A**

Connector: **JVLCD**

Type: 6-pin Power select Header

Pin	Description
1-2	LCDVCC (3.3V)
3-4	LCDVCC (5V)
5-6	LCDVCC (12V)

Default setting: **1-2**

Connector: **CN_LVDS**

Type: onboard 40-pin connector for LVDS connector

Connector model: **HIROSE DF13-40DP-1.25V**

Pin	Signal	Pin	Signal
2	LCDVCC	1	LCDVCC
4	GND	3	GND
6	ATX0-	5	BTX0-
8	ATX0+	7	BTX0+
10	GND	9	GND
12	ATX1-	11	BTX1-
14	ATX1+	13	BTX1+
16	GND	15	GND
18	ATX2-	17	BTX2-
20	ATX2+	19	BTX2+
22	GND	21	GND
24	ACLK-	23	N/C
26	ACLK+	25	N/C
28	GND	27	GND
30	N/C	29	BCLK-
32	N/C	31	BCLK+
34	GND	33	GND
36	N/C	35	N/C
38	N/C	37	N/C
40	N/C	39	N/C

FE-97G User's Manual

To setup the LCD, you need the component below:

1. A panel with LVDS interfaces.
2. An inverter for panel's backlight power.
3. A LCD cable and an inverter cable.

For the cables, please follow the pin assignment of the connector to make a cable, because every panel has its own pin assignment, so we do not provide a standard cable; please find a local cable manufacture to make cables.

LCD Installation Guide:

1. Preparing the **FE-97G, LCD panel** and the **backlight inverter**.

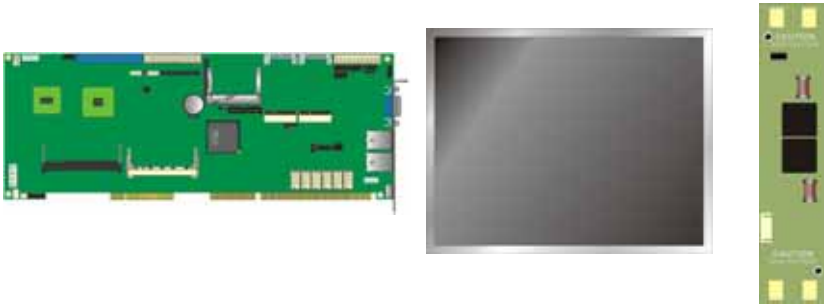

2. Please check the datasheet of the panel to see the voltage of the panel, and set the jumper **JVLCD** to +12V or +5V or +3.3V.
3. You would need a LVDS type cable.

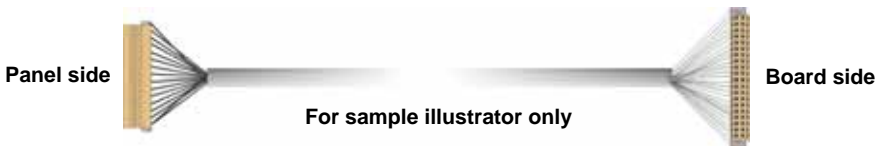

4. To connect all of the devices well.

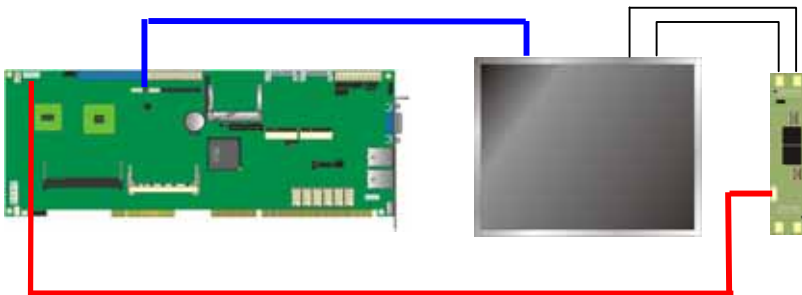

After setup the devices well, you need to select the LCD type in the BIOS.
The panel type mapping is list below:

BIOS panel type selection form			
On board 18 bit LVDS			
Single Channel		Dual Channel	
NO.	Output format	No.	Output format
1.	640 x 480	9.	1280 x 768
2.	800 x 480		
3.	800 x 600		
4.	1024 x 600		
5.	1024 x 768		
6.	1280 x 600		
7.	1280 x 768		
8.	1280 x 800		

2.9.3 <HDTV Interface>

The board provides an HDTV interface with Intel 945GSE, supports Composite, S-Video and Component with PAL and NTSC of TV system, and display (clone or extended desktop) function with VGA, LVDS, DVI.

Connector: **CN_HDTV**



Connector type: 10-pin header HDTV connector (pitch = 2.54mm)

Pin Number	Assignment	Pin Number	Assignment
1	GND	2	DACB_L
3	DACC_L	4	GND
5	GND	6	N/C
7	DACA_L	8	GND
9	N/C	10	N/C

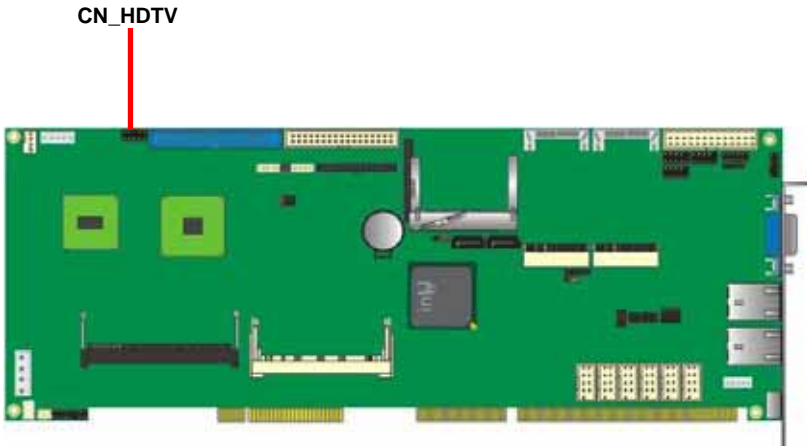

2.9.4 <DVI Interface >

The board also comes with a DVI interface with Chronitel CH7307C for digital video interface.

Connector: **CN_DVI**

Connector type: 26-pin header connector (pitch = 2.00mm)

Pin Number	Assignment	Pin Number	Assignment
1	TX1+	2	TX1-
3	Ground	4	Ground
5	TXC+	6	TXC-
7	Ground	8	PVDD
9	N/C	10	N/C
11	TX2+	12	TX2-
13	Ground	14	Ground
15	TX0+	16	TX0-
17	N/C	18	HPDET
19	DDCDATA	20	DDCCLK
21	GND	22	N/C
23	N/C	24	N/C
25	N/C	26	N/C

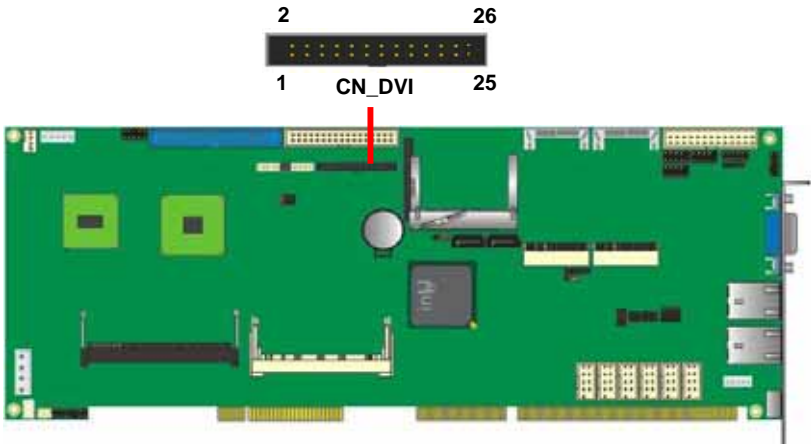

2.10 <Integrated Audio Interface>

The board integrates onboard audio interface with REALTEK ALC655 codec, with Intel next generation of audio standard as High Definition Audio, it offers more sound and other advantages than former HD audio compliance.

The main specifications of ALC655 are:

- **High-performance DACs with 97dB SNR (A-Weighting),**
- **Ten DAC channels support 16/20/24-bit PCM format for 2 sound playback, plus 2 channels of independent stereo sound output (multiple streaming) through the front panel output**
- **High-quality analog differential CD input**
- **Meets performance requirements for Microsoft WLP 3.0 Premium desktop and mobile PCs**

The board provides 2 channels audio speaker out and Mic-In ports for front I/O panel through cable.

Connector: CN_AUDIO

Type: 10-pin (2 x 5) 2.54mm-pitch header



Pin	Description	Pin	Description
1	MIC2_L	2	Ground
3	MIC2_R	4	VCC
5	FP_OUT_R	6	MIC2_JD
7	SENSE_B	8	N/C
9	FP_OUT_L	10	LINE2_JD



Connector: CD_IN

Type: 4-pin header (pitch = 2.54mm)

Pin	Description
1	CD – Left
2	Ground
3	Ground
4	CD – Right

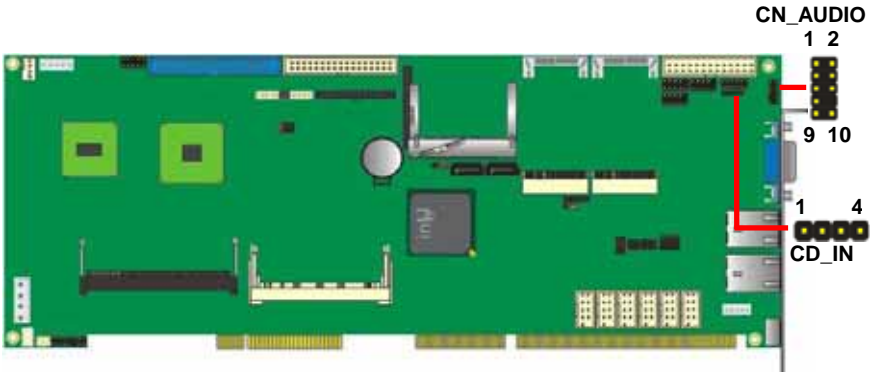

2.11 <GPIO Interface>

The board provides a programmable 8-bit digital I/O interface; you can use this general purpose I/O port for system control like POS or KIOSK.

Connector: **CN_DIO**

Type: 12-pin (6 x 2) 2.0mm-pitch header



Pin	Description	Pin	Description
1	Ground	2	Ground
3	GP10	4	GP14
5	GP11	6	GP15
7	GP12	8	GP16
9	GP13	10	GP17
11	VCC	12	+12V

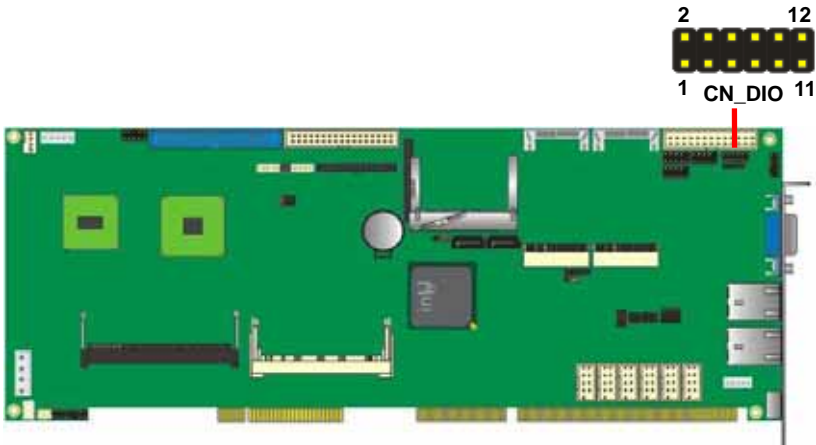

2.12 <Power and Fan Installation>

The board comes with a 4-pin AT power connector for powering the board, three fan connectors for Northbridge, CPU and system. The board also provides a 3-pin ATX function connector. You can just connect the two power connectors without any backplane to work.

2.12.1 <Power connectors>

Connector: **DC_IN**

Type: 4-pin P-type connector for +5V/+12V input

Pin	Description	Pin	Description	Pin	Description	Pin	Description
1	+12V	2	Ground	3	Ground	4	+5V

Connector: **CN_PS**

Type: 3-pin ATX function connector

Pin	Description	Pin	Description	Pin	Description
1	5V Standby	2	Ground	3	Power On

2.12.2 <Fan Connectors>

Connector: **CPUFAN**

Type: 4-pin fan wafer connector

Pin	Description	Pin	Description
1	Ground	2	+12V
3	Fan Speed Detection	4	Fan Control

Connector: **SYSFAN**

Type: 3-pin fan wafer connector

Pin	Description	Pin	Description	Pin	Description
1	Ground	2	+12V	3	Fan Speed Detection

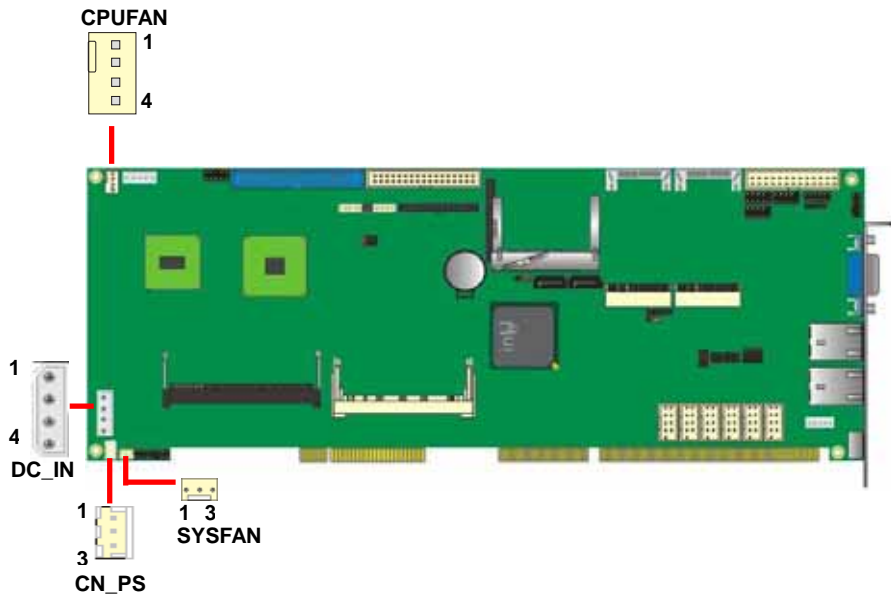

2.12.3 <ATX Power Mode>

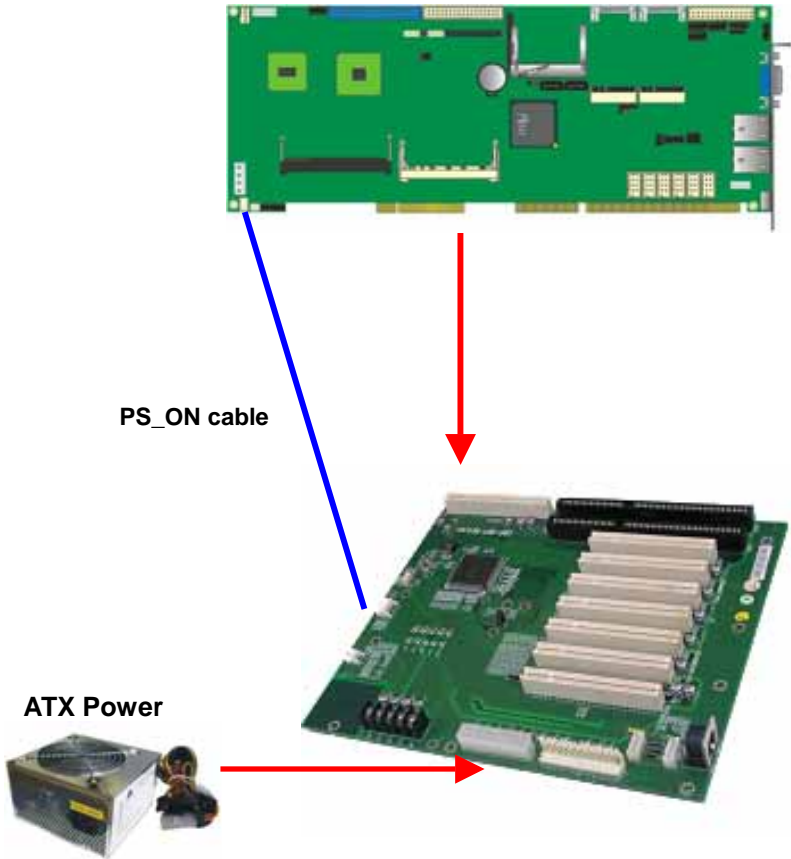

2.13 <Switch and Indicator>

The **JFRNT** provides front control panel of the board, such as power button, reset and beeper, etc. Please check well before you connecting the cables on the chassis.

Connector: **JFRNT**

Type: onboard 14-pin (2 x 7) 2.54-pitch header

Function	Signal	PIN		Signal	Function
IDE LED	HDLED+	1	2	PWRLED+	Power LED
	HDLED-	3	4	N/C	
Reset	Reset+	5	6	PWRLED-	Speaker
	Reset-	7	8	SPK+	
N/C		9	10	N/C	
Power Button	PWRBT+	11	12	N/C	
	PWRBT-	13	14	SPK-	

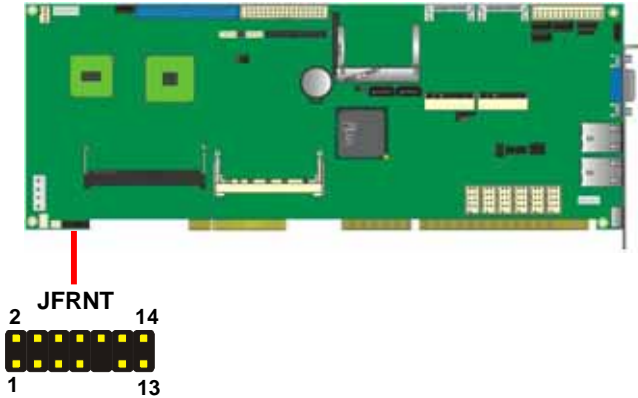

Chapter 3 <System Setup>

3.1 <Audio Configuration>

The board integrates Intel® ICH8M with REALTEK® ALC665 codec. It can support 2 channels sound under system configuration. Please follow the steps below to setup your sound system.

1. Install REALTEK HD Audio driver.
2. Lunch the control panel and Sound Effect Manager.

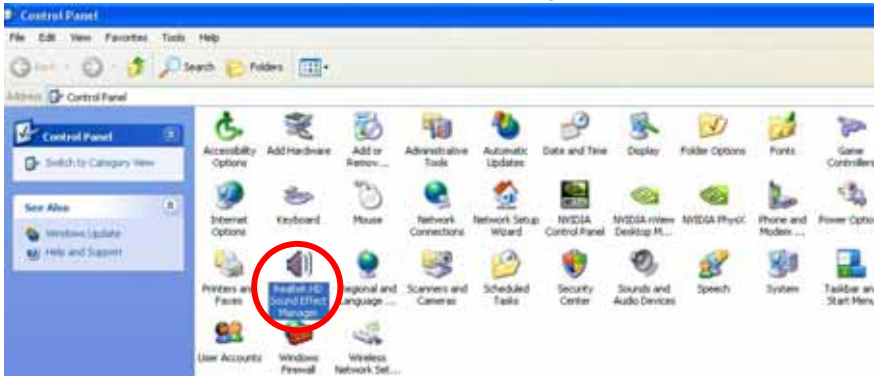

3. Select Speaker Configuration



4. Select the sound mode to meet your speaker system.

3.2 <Video Memory Setup>

Based on Intel® 945GSE chipset with GMA (Graphic Media Accelerator) 4500MHD, the board supports Intel® DVMT (Dynamic Video Memory Technology) 4.0, which would allow the video memory to be allocated up to 1024MB.

To support DVMT, you need to install the Intel GMA 4500MHD Driver with supported OS.

BIOS Setup:



Total GFX Memory Size:

This item can let you select a static amount of page-locked graphics memory which will be allocated during driver initialization. Once you select the memory amount, it will be no longer available for system memory.

DVMT Mode: This item can let you select graphics memory

3.3 <Display Properties Setting>

Based on Intel 945GSE GMCH with GMA 4500MHD (Graphic Media Accelerator), the board supports two DACs for display device as different resolution and color bit. Please install the Intel Graphic Driver before you starting setup display devices.

1. Click right button on the desktop to lunch **display properties**

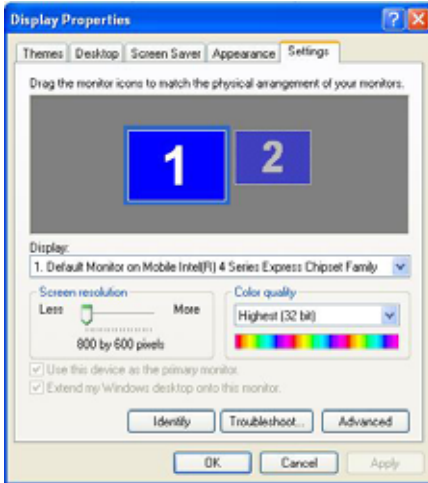

2. Click **Advanced** button for more specificity setup.



Click **Graphics Properties...** for advanced setup

3. This setup options can let you define each device settings.

Click **Monitor** to setup the CRT monitor for Colors, Resolution and Refresh Rate

Click **Intel(R) Dual Display Clone** to setup the dual display mode as same screen

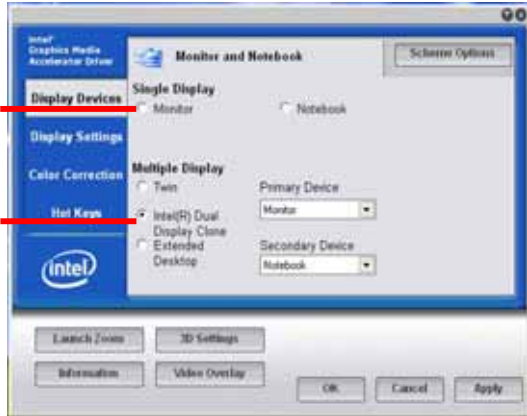

Chapter 4 <BIOS Setup>

The motherboard uses the Award BIOS for the system configuration. The Award BIOS in the single board computer is a customized version of the industrial standard BIOS for IBM PC AT-compatible computers. It supports Intel x86 and compatible CPU architecture based processors and computers. The BIOS provides critical low-level support for the system central processing, memory and I/O sub-systems.

The BIOS setup program of the single board computer let the customers modify the basic configuration setting. The settings are stored in a dedicated battery-backed memory, NVRAM, retains the information when the power is turned off. If the battery runs out of the power, then the settings of BIOS will come back to the default setting.

The BIOS section of the manual is subject to change without notice and is provided here for reference purpose only. The settings and configurations of the BIOS are current at the time of print, and therefore they may not be exactly the same as that displayed on your screen.

To activate CMOS Setup program, press key immediately after you turn on the system. The following message "Press DEL to enter SETUP" should appear in the lower left hand corner of your screen. When you enter the CMOS Setup Utility, the Main Menu will be displayed as **Figure 4-1**. You can use arrow keys to select your function, press <Enter> key to accept the selection and enter the sub-menu.

Figure 4-1 CMOS Setup Utility Main Screen

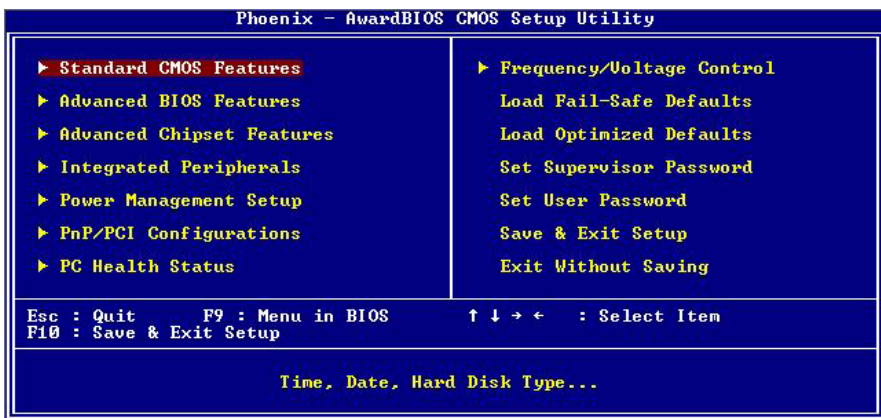

(This page is left for blank)

Appendix A <I/O Port Pin Assignment>

A.1 <Serial ATA Port>

Connector: **SATA1/2**

Type: 7-pin wafer connector

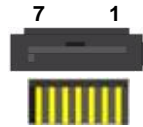

1	2	3	4	5	6	7
GND	SATA_TXP0	SATA_TXN0	GND	SATA_RXN0	SATA_RXP0	GND

A.2 <IrDA Port>

Connector: **CN_IR**

Type: 5-pin header for SIR Ports

Pin	Description
1	VCC
2	N/C
3	IRRX
4	Ground
5	IRTX



JCSEL1 must jump to "IrDA"

A.3 <SMBUS Port>

Connector: **CN_SMBUS**

Type: 5-pin header for SMBUS Ports

Pin	Description
1	V5S
2	N/C
3	SMBDATA
4	SMBCLK
5	Ground



A.4 <Serial Port 2>

Connector: **CN_COM2**

Type: 9-pin box header

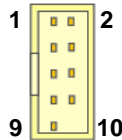

Pin	Description	Pin	Description
1	DCD/422TX-/485-/ +5V	2	RX/422TX+/485+
3	TX/422RX+	4	DTR/422RX-
5	Ground	6	DSR
7	RTS	8	CTS
9	RI /+12V		

A.5 < RS-232, RS-422, RS-485 & IrDA >

Function	JCSEL1	JCSEL2
IrDA		
RS-422		
RS-485		
RS-232		

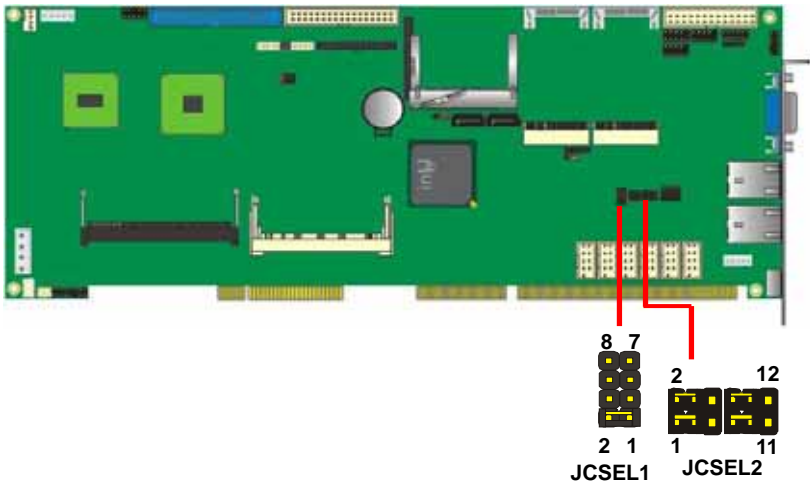

A.6 <Parallel Port>

Connector: **LPT**

Type: 26-Pin box header

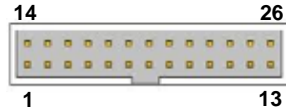

Pin	Description	Pin	Description
1	-PSTB	14	AFD-
2	PRO0	15	ERR-
3	PRO1	16	INT-
4	PRO2	17	SLIN-
5	PRO3	18	Ground
6	PRO4	19	Ground
7	PRO5	20	Ground
8	PRO6	21	Ground
9	PRO7	22	Ground
10	ACK-	23	Ground
11	BUSY	24	Ground
12	PE	25	Ground
13	SLCT	26	N/C

A.7 <LAN Port>

Connector: **RJ45_1/2**

Type: RJ45 connector with LED

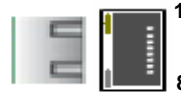

Pin	1	2	3	4	5	6	7	8
Description	MI0+	MI0-	MI1+	MI2+	MI2-	MI1-	MI3+	MI3-

A.8 <USB Interface>

Connector: **CN_USB 1/2/3**

Type: 10-pin (5 x 2) header for dual USB Ports

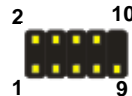

Pin	Description	Pin	Description
1	VCC	2	VCC
3	Data0-	4	Data1-
5	Data0+	6	Data1+
7	Ground	8	Ground
9	Ground	10	N/C

A.9 <DVI Port>

Connector: **CN_DVI**

Type: onboard 26-pin connector for DVI connector



Pin	Description	Pin	Description
1	TDC1+	2	TDC1-
3	GND	4	GND
5	TLC+	6	TLC-
7	GND	8	V5S
9	N/C	10	N/C
11	TDC2+	12	TDC2-
13	GND	14	GND
15	TDC0+	16	TDC0-
17	N/C	18	HPD
19	DVI_DA	20	DVI_SL
21	GND	22	BR
23	BG	24	BB
25	5HSYNC	26	5VSYNC

A.10 <PS/2 Keyboard & Mouse Port>

Connector: **PS2**

Type: 6-pin Mini-DIN connector on bracket

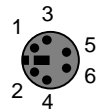

Pin	1	2	3	4	5	6
Description	KBD	MSD	Ground	VCC	KBC	MSC

Note: The PS/2 connector supports standard PS/2 keyboard directly or both PS/2 keyboard and mouse through the PS/2 Y-type cable.

Appendix B <Flash BIOS>

B.1 <Flash Tool>

The board is based on Award BIOS and can be updated easily by the BIOS auto flash tool. You can download the tool online at the address below:

<http://www.phoenix.com/en/home/>

http://www.commell.com.tw/Support/Support_SBC.htm

File name of the tool is "awdfash.exe", it's the utility that can write the data into the BIOS flash chip and update the BIOS.

B.2 <Flash BIOS Procedure>



1. Please make a bootable floppy disk.
2. Get the last .bin files you want to update and copy it into the disk.
3. Copy awardflash.exe to the disk.
4. Power on the system and flash the BIOS. (Example: C:/ awdfash XXX.bin)
5. Restart the system.

Any question about the BIOS re-flash please contact your distributors or visit the web-site at below:



























<ftp://ftp.commell.com.tw/COMMELL/support/AWDFLASH.rar>

Appendix C <System Resources>











































C.1 <Direct Memory Access (DMA)>











-  2 Standard floppy disk controller
-  4 Direct memory access controller

C.2 <Direct Memory Access (IRQ)>



























-  (ISA) 0 System timer
-  (ISA) 1 Standard 101/102-Key or Microsoft Natural PS/2 Keyboard
-  (ISA) 3 Communications Port (COM2)
-  (ISA) 4 Communications Port (COM1)
-  (ISA) 5 Communications Port (COM5)
-  (ISA) 6 Standard floppy disk controller
-  (ISA) 7 Communications Port (COM3)
-  (ISA) 7 Communications Port (COM4)
-  (ISA) 8 System CMOS/real time clock
-  (ISA) 9 Microsoft ACPI-Compliant System
-  (ISA) 11 Communications Port (COM6)
-  (ISA) 13 Numeric data processor
-  (ISA) 14 Primary IDE Channel
-  (ISA) 15 Secondary IDE Channel
-  (PCI) 11 Intel(R) 82801G (ICH7 Family) SMBus Controller - 27DA
-  (PCI) 16 Intel(R) 82574L Gigabit Network Connection #2
-  (PCI) 16 Intel(R) 82801G (ICH7 Family) PCI Express Root Port - 27D0
-  (PCI) 16 Intel(R) 82801G (ICH7 Family) USB Universal Host Controller - 27CB
-  (PCI) 16 Mobile Intel(R) 945 Express Chipset Family
-  (PCI) 17 Intel(R) 82574L Gigabit Network Connection
-  (PCI) 17 Intel(R) 82801G (ICH7 Family) PCI Express Root Port - 27D2
-  (PCI) 17 Realtek AC'97 Audio
-  (PCI) 18 Intel(R) 82801G (ICH7 Family) USB Universal Host Controller - 27CA
-  (PCI) 19 Intel(R) 82801G (ICH7 Family) USB Universal Host Controller - 27C9
-  (PCI) 23 Intel(R) 82801G (ICH7 Family) USB Universal Host Controller - 27C8
-  (PCI) 23 Intel(R) 82801G (ICH7 Family) USB2 Enhanced Host Controller - 27CC

C.3 <Input /Output (IO)>

	[00000000 - 0000000F] Direct memory access controller
	[00000000 - 00000CF7] PCI bus
	[00000010 - 0000001F] Motherboard resources
	[00000020 - 00000021] Programmable interrupt controller
	[00000022 - 0000003F] Motherboard resources
	[00000040 - 00000043] System timer
	[00000044 - 0000005F] Motherboard resources
	[00000060 - 00000060] Standard 101/102-Key or Microsoft Natural PS/2 Keyboard
	[00000061 - 00000061] System speaker
	[00000062 - 00000063] Motherboard resources
	[00000064 - 00000064] Standard 101/102-Key or Microsoft Natural PS/2 Keyboard
	[00000065 - 0000006F] Motherboard resources
	[00000070 - 00000073] System CMOS/real time clock
	[00000074 - 0000007F] Motherboard resources
	[00000080 - 00000090] Direct memory access controller
	[00000091 - 00000093] Motherboard resources
	[00000094 - 0000009F] Direct memory access controller
	[000000A0 - 000000A1] Programmable interrupt controller
	[000000A2 - 000000BF] Motherboard resources
	[000000C0 - 000000DF] Direct memory access controller
	[000000E0 - 000000EF] Motherboard resources
	[000000F0 - 000000FF] Numeric data processor
	[00000170 - 00000177] Secondary IDE Channel
	[000001F0 - 000001F7] Primary IDE Channel
	[00000274 - 00000277] ISAPNP Read Data Port
	[00000279 - 00000279] ISAPNP Read Data Port
	[000002E8 - 000002EF] Communications Port (COM4)
	[000002F8 - 000002FF] Communications Port (COM2)
	[00000376 - 00000376] Secondary IDE Channel
	[00000378 - 0000037F] Printer Port (LPT1)
	[000003B0 - 000003BB] Mobile Intel(R) 945 Express Chipset Family
	[000003C0 - 000003DF] Mobile Intel(R) 945 Express Chipset Family
	[000003E8 - 000003EF] Communications Port (COM3)
	[000003F0 - 000003F5] Standard floppy disk controller
	[000003F6 - 000003F6] Primary IDE Channel
	[000003F7 - 000003F7] Standard floppy disk controller
	[000003F8 - 000003FF] Communications Port (COM1)
	[00000400 - 000004BF] Motherboard resources
	[000004D0 - 000004D1] Motherboard resources
	[000004E8 - 000004EF] Communications Port (COM6)
	[000004F8 - 000004FF] Communications Port (COM5)
	[00000500 - 0000051F] Intel(R) 82801G (ICH7 Family) SMBus Controller - 27DA
	[00000778 - 0000077B] Printer Port (LPT1)
	[00000880 - 0000088F] Motherboard resources
	[00000A79 - 00000A79] ISAPNP Read Data Port
	[00000D00 - 0000FFFF] PCI bus
	[00008000 - 0000BFFF] Intel(R) 82801G (ICH7 Family) PCI Express Root Port - 27D2

	[0000BF00 - 0000BF1F]	Intel(R) 82574L Gigabit Network Connection
	[0000C000 - 0000CFFF]	Intel(R) 82801G (ICH7 Family) PCI Express Root Port - 27D0
	[0000CF00 - 0000CF1F]	Intel(R) 82574L Gigabit Network Connection #2
	[0000F000 - 0000F0FF]	Realtek AC'97 Audio
	[0000F800 - 0000F80F]	Intel(R) 82801GBM/GHM (ICH7-M Family) Serial ATA Storage Controller - 27C4
	[0000FA00 - 0000FA3F]	Realtek AC'97 Audio
	[0000FB00 - 0000FB1F]	Intel(R) 82801G (ICH7 Family) USB Universal Host Controller - 27CB
	[0000FC00 - 0000FC1F]	Intel(R) 82801G (ICH7 Family) USB Universal Host Controller - 27CA
	[0000FD00 - 0000FD1F]	Intel(R) 82801G (ICH7 Family) USB Universal Host Controller - 27C9
	[0000FE00 - 0000FE1F]	Intel(R) 82801G (ICH7 Family) USB Universal Host Controller - 27C8
	[0000FF00 - 0000FF07]	Mobile Intel(R) 945 Express Chipset Family

C.4 <Memory Address Map>

	[00000000 - 0009FFFF] System board
	[000A0000 - 000BFFFF] Mobile Intel(R) 945 Express Chipset Family
	[000A0000 - 000BFFFF] PCI bus
	[000C0000 - 000DFFFF] PCI bus
	[000E0000 - 000EFFFF] System board
	[000F0000 - 000FFFFF] System board
	[00100000 - 3F6DFFFF] System board
	[3F6E0000 - 3F6FFFFF] System board
	[3F750000 - FEBFFFFF] PCI bus
	[D0000000 - DFFFFFFF] Mobile Intel(R) 945 Express Chipset Family
	[E0000000 - EFFFFFFF] Motherboard resources
	[FD800000 - FD8FFFFF] Intel(R) 82801G (ICH7 Family) PCI Express Root Port - 27D2
	[FD900000 - FD9FFFFF] Intel(R) 82801G (ICH7 Family) PCI Express Root Port - 27D2
	[FD9C0000 - FD9CFFFF] Intel(R) 82574L Gigabit Network Connection
	[FD9FC000 - FD9F9FFF] Intel(R) 82574L Gigabit Network Connection
	[FDA00000 - FDAFFFFF] Intel(R) 82801G (ICH7 Family) PCI Express Root Port - 27D0
	[FDD00000 - FDDFFFFF] Intel(R) 82801G (ICH7 Family) PCI Express Root Port - 27D0
	[FDDC0000 - FDDDFFFF] Intel(R) 82574L Gigabit Network Connection #2
	[FDDFC000 - FDDF9FFF] Intel(R) 82574L Gigabit Network Connection #2
	[FDF00000 - FDF7FFFF] Mobile Intel(R) 945 Express Chipset Family
	[FDF80000 - FDFBFFFF] Mobile Intel(R) 945 Express Chipset Family
	[FDFFD000 - FDFFD0FF] Realtek AC'97 Audio
	[FDFFE000 - FDFFE1FF] Realtek AC'97 Audio
	[FDFFF000 - FDFFF3FF] Intel(R) 82801G (ICH7 Family) USB2 Enhanced Host Controller - 27CC
	[FEB80000 - FEBFFFFF] Mobile Intel(R) 945 Express Chipset Family
	[FEC00000 - FEC0FFFF] System board
	[FED13000 - FED1DFFF] System board
	[FED20000 - FED8FFFF] System board
	[FEE00000 - FEE0FFFF] System board
	[FFB00000 - FFB7FFFF] System board
	[FFB80000 - FFBFFFFF] Intel(R) 82802 Firmware Hub Device
	[FFF00000 - FFFFFFFF] System board

Appendix D <Programming GPIO's>

The GPIO's can be programmed with the MSDOS debug program using simple IN/ OUT commands. The following lines show an example how to do this.

GPIO0.....GPIO7 bit0.....bit7

-o 2E 87

-o 2E 87 ;Enter configuration

-o 2E 07

-o 2F 09 ;Enable GPIO's function

-o 2E 30

-o 2F 02 ;Enable GPIO's configuration

-o 2E F0

-o 2F xx ;Set GPIO's as input/output; set '1' for input,'0'for output

-o 2E F1

-o 2F xx ;If set GPIO's as output, in this register its value can be set

Optional:

-o 2E F2

-o 2F xx ; Data inversion register; '1' inverts the current value of the bits,'0' leaves them as they are

-o 2E 30

-o 2F 01 ; Active GPIO's

For further information, please refer to Winbond W83627DHG datasheet.

Appendix E <Programming Watchdog Timer>

The watchdog timer makes the system auto-reset while it stops to work for a period.

The integrated watchdog timer can be setup as system reset mode by program.

Time-out Value Range

- 1 to 255

- Second or Minute

Program Sample

Watchdog timer setup as system reset with 5 second of timeout

2E, 87	
2E, 87	
2E, 07	
2F, 08	Logical Device 8
2E, 30	
2F, 01	Activate
2E, F5	
2F, 00	Set as Second*
2E, F6	
2F, 05	Set as 5

* Minute: bit 3 = 1; Second: bit 3 = 0

You can select Timer setting in the BIOS, after setting the time options, the system will reset according to the period of your selection.

Contact Information

Any advice or comment about our products and service, or anything we can help you please don't hesitate to contact with us. We will do our best to support you for your products, project a business.

Taiwan Commate Computer Inc.

Address	19F, No. 94, Sec. 1, Shin Tai Wu Rd., Shi Chih Taipei Hsien, Taiwan
TEL	+886-2-26963909
FAX	+886-2-26963911
Website	http://www.commell.com.tw
E-Mail	info@commell.com.tw (General Information) tech@commell.com.tw (Technical Support)

Commell is a brand name of Taiwan Commate Computer Inc.